

Introducing your Meridian Digital Telephone 1

Meridian Digital Telephones 1

M3820 1

M3310 2

M3110 3

Selecting a position for your Meridian Digital Telephone 4

Parts of your Meridian Digital Telephone 5

Your Telephone's Display 6

Idle screen format 6

Calling party information 6

Display options 6

Using Display Options 7

Your telephone's features 12

Initiating Calls 12

To call using the dial pad 13

Answering Calls 13

Placing a call on hold 13

Call Transfer 14

On-hook dialing 15

Predial 15

Last Number Redial 16

Handsfree 16

Group Listening 17

Directory (M3820 only) 18

Callers List and Redial List (M3820 only) 21

Making a call 25

Auto Dial 25

Ring Again 25

Speed Call 26

System Speed Call 28

Call Page 28

Override 29

Override, Enhanced 29

Stored Number 30

Buzz 30
Forced Camp-on 31
Call Charge/Forced Charge 31
Hot Line 33
Radio Paging 33
Voice Call 35

Receiving a call 37

Call Waiting 37
Call Pickup 38
Timed Recall Reminder 39
Automatic Answerback 39

During a call 41

Call Transfer 41
Auto Dial Transfer 41
Call Park 42
Attendant Recall 43
Display 43
Call Charge 44
On Hold on Loudspeaker 44
Malicious Call Trace 46
Centrex/Exchange Switchhook Flash 46

While you are away from your desk 47

Call Forward 47
Call Forward - Internal 48
Remote Call Forward 49
Electronic Lock 51
Intercom 52

To talk with more than one person 53

Conference 53
Group Call 54
Call Join 55
Privacy Release 56

Working without interruption 57

Call Forward 57

Make Busy 58

Hospitality features 59

Automatic Wake-Up 59

Message Registration 60

Maid Identification 61

Room Status 62

Options 64

Your Telephone's Controls 65

Terms you should know 67

FFCs 68

Introducing your Meridian Digital Telephone

This guide introduces you to your new Meridian digital telephone. It provides you with a description of the controls, and a description of the features that are available to you.

Meridian Digital Telephones

There are three different models of the Meridian Digital Telephone and the following are features of each type:

M3820



- Handsfree
- On-Hook Dialing
- Group Listening
- Speaker/Mute Indicator
- Message Waiting Indicator
- Headset Socket
- Wall Mount Capability
- 2 x 24 Character Display
- 13 configurable Feature Keys
- Volume Control Bar for:
 - Ringing Tone
 - Buzz Tone
 - Speaker
 - Handset/Headset
 - Handsfree/Group Listening
- Directory List supporting 75 entries
- Callers List supporting 20 entries
- Redial List supporting 5 entries

Support for the following set options:

- MCA data option to provide integrated voice and data transmission
- External Alert Interface for high ambient noise environments
- Add-on 22 configurable Feature Key Expansion Modules (2 maximum)

M3310



Handsfree

On-Hook Dialing

Group Listening

Speaker/Mute Indicator

Message Waiting Indicator

Headset Socket

Wall Mount Capability

2 x 24 Character Display

7 configurable Feature Keys

Volume Control Bar for:

- Ringing Tone
- Buzz Tone
- Speaker
- Handset/Headset
- Handsfree/Group Listening

Support for the following set options:

- MCA data option to provide integrated voice and data transmission
- External Alert Interface for high ambient noise environments

M3110



On-Hook Dialing

Group Listening

Speaker/Mute Indicator

Message Waiting Indicator

Wall Mount Capability

8 configurable Feature Keys

Volume Control Bar for:

- Ringing Tone
- Buzz Tone
- Speaker
- Handset
- Group Listening

Support for the following set options:

- MCA data option to provide integrated voice and data transmission
- External Alerter Interface for high ambient noise environments

Selecting a position for your Meridian Digital Telephone



Low Position



High Position (Default)



Wall Mount

- On Your Desk: Your Meridian Digital Telephone can be placed on your desk so that it is tilted upwards making it easier to see the display; there are two positions for the desk.

- On the wall: The wall mount lets you attach your telephone on the wall by rotating the base. All three Meridian Digital Telephone models can be wall mounted.
- Contact your System Administrator if you wish to change the position of your Meridian Digital Telephone.

Parts of your Meridian Digital Telephone

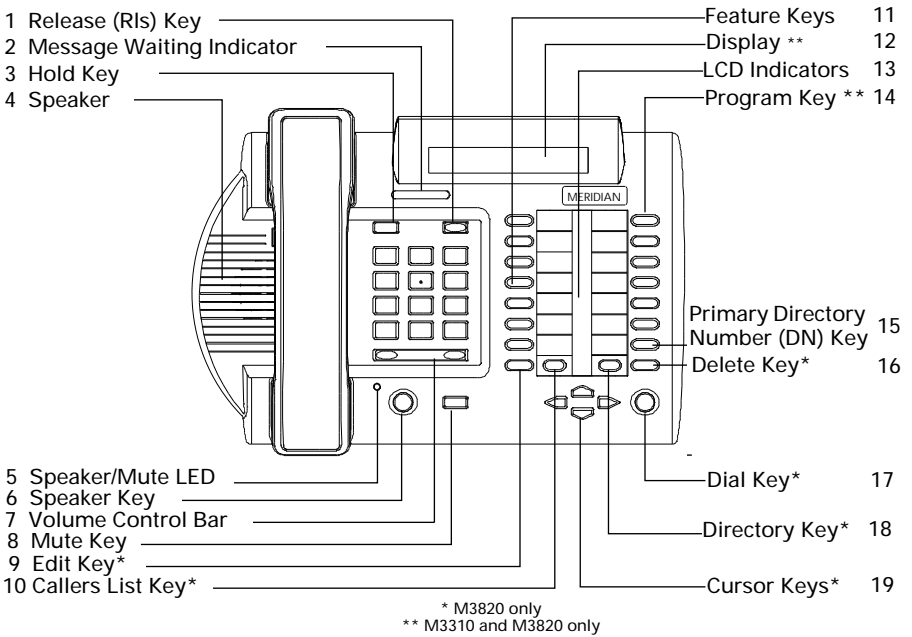

The preceding figure shows the location of the control buttons on your Meridian Digital Telephone. Please refer to the section titled *Your Telephone's Controls*, located near the back of this guide, for information on the functions performed by each of these buttons.

Your Telephone's Display

Idle screen format

The Meridian M3820 and M3310 are equipped with a 2 x 24 character display module. The idle display, as shown below, gives the current date and time.



When you go off hook, the time and date disappear and information about your call is displayed.

Calling party information

When your phone rings, information about the incoming call is displayed. The phone number and name of the person calling may appear in the display module if this information is available.

Display options

An additional function of the display is using it to show information when programming various functions. By pressing the **Program** Key, you can scroll through different adjustable features on your telephone. Scroll by using the **Volume Control Bar**.

You may select the following adjustable features:

*1 GROUP LISTENING	02 CONTRAST ADJUSTMENT
* *2 CALLERS LIST	03 CALL TIMER ENABLE
* *3 CALLERS SAVED	04 IDLE SCREEN FORMAT
* *4 DIRECTORY	05 LANGUAGE SELECTION
00 VOLUME ADJUSTMENT	07 DISPLAY DIAGNOSTICS
01 PREDIAL RECALL	09 KEY CLICK

* M3820 only

Under each of the above possible adjustable features on your display, it will read **SELECT OR SCROLL << >>** . For instance, if you are displaying **03 CALL TIMER ENABLE** , you may select this feature to program it by pushing **0 3** , or you may push the right side of the volume control bar once to scroll to **04 IDLE SCREEN FORMAT** or push the left side of the volume control bar once to get to **02 CONTRAST ADJUSTMENT** .

Using Display Options

Group Listening



Follow these steps to change the status (enabled/disabled) of the Group Listening feature on your telephone:

1. Press the **Program** Key.
2. Press ***** then **1** .
3. Use the **Volume Control Bar** to toggle between enabled and disabled.
4. Press the **Program** Key when the desired status is visible.

This option cannot be programmed when a headset is connected, as group listening is automatically selected.

Callers List (M3820 only)



Follow these steps to change the status (enabled/disabled) of the Callers List flashing LCD indicator:

1. Press the **Program** Key.
2. Press ***** then **2** .
3. Use the **Volume Control Bar** to enable/disable the flashing indicator for the Callers List.
4. Press the **Program** Key when the desired status is visible.

Callers Saved (M3820 only)



Program

Delete Directory (M3820 only)

Program

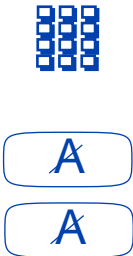

Follow these steps to select whether the Callers List saves all calls or only those which are not answered:

1. Press the **Program** Key.
2. Press ***** then **3**.
3. Use the **Volume Control Bar** to select all calls/unanswered calls to be saved to the Callers List.
4. Press the **Program** Key when the desired status is visible.

Follow these steps to delete all entries in the directory:

1. Press the **Program** Key.
2. Press ***** then **4**.
3. Press the **Delete** Key.
4. Press the **Delete** Key again to delete the directory.

If you do not push any buttons on your telephone for six seconds, the delete action will be ignored and the screen will display the directory entry again.

5. Press the **Directory** Key.

Volume Adjustment

Program



Program

It is easy to adjust the volume on your telephone by following these steps:

1. Press the **Program** Key.
2. Press **0** then **0**. Follow by pressing **1** to adjust the ringing tone. Pressing **2** allows you to adjust the buzzer tone. Press **3** to adjust the speaker volume. Press **4** to adjust the volume of the handset and press **5** "handsfree" (if it is configured.)
3. Press the **Volume Control Bar** on the left to reduce the volume; press the volume control bar on the right to increase the volume.
4. Press the **Program** Key.

Predial recall

Program



To display the last number predialed:

1. Press the **Program** Key.
2. Press **0** then **1**.

Contrast Adjustment

Program



You may need to adjust how light/dark the text is in your display depending on the tilt of your display and the lighting in the environment where the phone is located. Follow these steps to make adjustments:

1. Press the **Program** Key.
2. Press **0** then **2**.



Program

3. Use the **Volume Control Bar** to increase or decrease the contrast.
4. Press the **Program** Key.

Call Timer Enable

Sometimes it is interesting to see how long we stay on the phone with certain customers or fellow employees. Follow these steps to enable the call timer.

Program



Program

1. Press the **Program** Key.
2. Press **0** then **3**.
3. Press the **Volume Control Bar** to toggle between **CALL TIMER ON** and **CALL TIMER OFF**.
4. Press the **Program** Key when the desired status is visible.

Idle Screen Format

Follow these steps to determine how your idle screen will look:

Program



Program

1. Press the **Program** Key.
2. Press **0** then **4**. **IDLE FORMAT** is displayed along with your current selection.
3. Press the **Volume Control Bar** to scroll through the various formats until you find the one that you like best.
4. Press the **Program** Key.

Language Selection

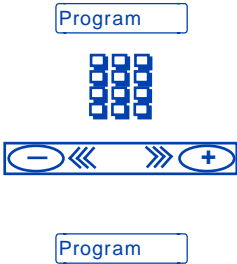

The information on your display can be displayed in one of several languages. Follow these steps to change your display to a different language:

1. Press the **Program** Key.
2. Press **0** then **5**.
3. Use the **Volume Control Bar** to scroll to the desired language.
4. Press the **Program** Key.

Display Diagnostics

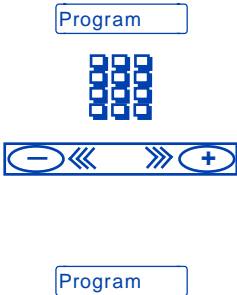

Select Display Diagnostics by following these steps:

1. Press the **Program** Key.
2. Press **0** then **7**.
3. Scroll through the various test screens using the **Volume Control Bar**.
4. Press the **Program** Key to end diagnostics mode.

Key Click

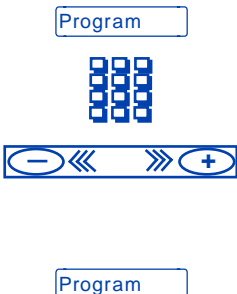

Follow these steps if you want to hear a tone each time you press a dial pad key:

1. Press the **Program** Key.
2. Press **0** then **9**.
3. Press the **Volume Control Bar** to toggle between **KEY CLICK ON** and **KEY CLICK OFF**.
4. Press the **Program** Key when the desired status is visible.

Your telephone's features

Your telephone system administrator assigns features to your programmable feature keys. Whenever this guide describes a procedure that requires special codes or passwords, ask your telephone system administrator to provide these to you.

To use a feature, you will be instructed to press a feature key, or enter an FFC code. You may be provided with Flexible Feature Codes (FFCs), which you will need in order to use some features. A table is located conveniently in the back of this guide for you to note FFCs.

Not all features are available in your area, and some require additional equipment.

Initiating Calls

There are several ways to initiate a call from your Meridian digital telephones depending on the model:



- Via the **DN** Key
- Via the **Dial** Key (M3820 only)
- Via the **Speaker** Key
- Via the **Handset**

Whenever you read “Lift the handset,” in this guide, you may alternatively press a DN Key, press the Speaker Key or Dial Key (if so equipped). Each of these actions will give you dial tone.

To call using the dial pad



2637



1. **Lift the handset** or press a **DN** Key.

Press a **DN** Key if no free line is selected automatically.

2. **Dial** the number.

Answering Calls

When you receive an incoming call, your telephone rings and the LCD indicator  flashes.

To answer a call, perform one of the following



2637



- **Lift the handset**
- Press the **Speaker** Key (Main DN only)
- Press the **DN** Key beside the flashing LCD indicator .
- Press the **Dial** Key (main DN only.)

Placing a call on hold

Use the Hold feature to place a call on hold. An example of where hold would be useful would be to answer a call on a second line without disconnecting from your original call.

To place a call on hold:

Hold

Press **Hold**. The LCD indicator  flashes beside the line on hold.

The caller may hear music if this is programmed on your system.

To retrieve a call on hold:

2637

Press the **DN** Key beside the flashing LCD indicator .

Call Transfer

Use the Transfer feature to redirect a call to a third party.

To transfer a call to another number:

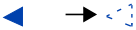

If the person you are calling is not available:

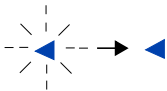

1. Press **Transfer**. The other party is on hold and you hear dial tone. The LCD indicator lights steadily.
2. **Dial** the DN that you want to transfer the call to.
3. Press **Transfer** again, either when you hear ringing, or after you talk privately to the person you are transferring the call to.

The LCD indicator goes from steady to off.

Press the **DN** Key beside the flashing LCD indicator. You will be reconnected with the call.

The LCD indicator goes from flashing to steady.

On-hook dialing

On-hook dialing allows you to dial a number without lifting the handset.

To use On-hook dialing:

2637



1. Press a **DN** Key.
2. Upon hearing dial tone, **Dial** the number.
3. **Lift the handset** when the called party answers or, if using handsfree, begin talking.

If the number you are calling is busy:

Rls or **Ring Again**

Press **Release** to release the line, or **Ring Again** if desired.

Predial

Predial allows you to enter and preview a number, making corrections if required, before dialing the number. Not recommended for the M3110 as it has no display.

To use Predial:



2637



1. Without lifting the handset or pressing a **DN** Key, **Dial** the number.
2. Preview the number.
3. Use the **Volume Control Bar** to backspace if you need to correct the number.
4. Press a free **DN** Key to dial the number.
5. **Lift the handset** when the called party answers, or if using handsfree, begin talking.

Last Number Redial

Last Number Redial allows you to automatically redial the last number you dialed.

To use Last Number Redial:



Last No.



2637

- **Lift the handset.**
- Press **Last Number** Key.

or

Press any of the following twice:

- **Speaker** Key
- **Dial** Key
- **DN** Key

Handsfree

If your telephone is a M3820 or a M3310, you can use the built-in microphone and speaker instead of the handset. At any time during a call, you can switch to the handset by picking it up.

To use Handsfree on a call:



Press the **Speaker** Key.

The Speaker/Mute LED is lit.

To discontinue a Handsfree call:

Rls

Press **Release** to end your call.

The Speaker/Mute LED goes out.

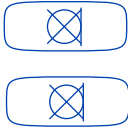
To mute a handsfree call:

1. Press the **Mute** Key. The speaker/mute LED flashes.
2. Press the **Mute** Key again to return to a two-way conversation.

The Speaker/Mute LED lights steadily.

To switch from the handset to Handsfree:

1. Press the **Speaker** Key.
2. Hold down the **Speaker** Key while **replacing the handset**.

The speaker/mute LED lights steadily.

Group Listening

The group listening feature allows you to listen to a call through the speaker while speaking through the handset, thus allowing a third party(ies) to listen to both sides of the conversation.

To activate group listening:

Lift the handset and press the **Speaker** Key.

To switch off the loudspeaker:

Press the **Speaker** Key again to return to the handset.

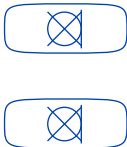
To mute a group listening call:

1. Press the **Mute** Key. The LED flashes.
2. Press the **Mute** Key again to return to two way conversation.

The speaker/mute LED lights steadily.

To switch from group listening to handsfree (M3310 and M3820 only):



Hold down the **Speaker** Key while replacing the handset.

To enable/disable group listening:

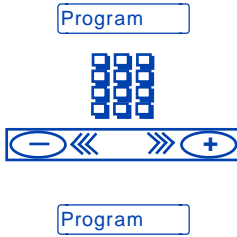

1. Press the **Program** Key.
2. Press ***** then **1** .
3. Use the **Volume Control Bar** to enable/disable group listening.
4. Press the **Program** Key.

This option cannot be programmed when a headset is connected, as group listening is automatically selected.

Directory (M3820 only)

The directory allows up to 75 names and numbers to be displayed in alphabetical order. It is convenient to have frequently called numbers here in the directory rather than having to look them up in your phone book. Also, after scrolling to the number, pushing the **Dial** Key will dial the number. The directory items with only a number are stored at the beginning of the directory.



It is possible to scroll steadily through the entire list by holding down either the **Up-arrow** or **Down-arrow** Key.

Entering Items into the Directory



1. Press the **Directory** Key.
2. Press the **Program** Key.
3. **Enter** digits.

The maximum number of digits you can enter is 19, after which key strokes are ignored.

Program



4. Press the **Program** Key.
5. **Enter** Name.

Pressing the same key multiple times will give you capital letters. For instance, if you push  seven times, you will see **a, b, c, A, B, C, 2**



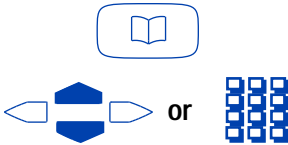

Press the **Up-arrow** key (from the Cursor keys) to place the dial pad in special characters mode (e.g. å, æ, ç, î, ï, ô, ú, ò). An **Asterisk** will be displayed. Pressing the **Up-arrow** key again will return the dial pad to normal mode.

Program

Finding items in the directory



6. Press the **Program** Key to save.

1. Press the **Directory** Key.
2. Scroll to select name or find the name you wish to dial using the letters on the dial pad. For example, for Alan, **Dial**    .

Deleting items from the Directory



When you have found the item you wish to delete:

1. Press the **Delete** Key.
2. Press the **Delete** Key again to delete.

If no buttons are pushed on your telephone, the delete action will be ignored and the screen will display the directory entry again.

Deleting the Directory

Program



Making a call from the Directory after finding the number you wish to dial





Directory Editing



or



Follow these steps to delete all entries in the Directory:





1. Press the **Program** Key.
2. Press  then .
3. Press the **Delete** Key.

If no buttons are pushed on your telephone, the delete action will be ignored and the screen will display the directory entry again.

4. Press the **Delete** Key again to delete.
5. Press the **Directory** Key to exit Directory deleting.

1. Press the **Dial** Key which dials the selected number.

2. Press the **Directory** Key.

3. **Scroll** to select name or find the name you wish to edit using the letters on the dial pad. For example, for Alan, **Dial**    .

If you do not push any buttons on your telephone for six seconds, the edit action will be ignored and the screen will display the directory entry again.

4. Press the **Edit** Key.



Program



Program

- Use **Cursor** Keys to move through numbers and make changes using the **Dial** pad.
- Press the **Program** Key to save.
- Use **Cursor** Keys to move through names and make changes using the **Dial** pad.
- Press the **Program** Key to save.

Callers List and Redial List (M3820 only)

The Callers List shows up to the last 20 calls made to the telephone. The Redial List shows the last 5 calls made from the telephone.

To enable/disable flashing LCD for caller's list:

Program



Program

- Press the **Program** Key.
- Press ***** then **2**.
- Use the **Volume Control Bar** to enable/disable the flashing LCD indicator for the Callers List.
- Press the **Program** Key.

To specify the type of incoming calls to be saved to the Callers List:

Program



Program

- Press the **Program** Key.
- Press ***** then **3**.
- Use the **Volume Control Bar** to select all calls/unanswered calls to be saved to the Callers List.
- Press the **Program** Key.

To view the List(s):

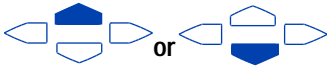

1. Press the **Callers List** Key.
2. Press **Up-arrow** for Redial List.
Press **Down-arrow** for Callers List.

To make a call from the Callers List:



1. **Scroll down** until the name or number appears that you wish to call.
2. Press the **Dial** Key.

The number may be edited, if required, by pressing the **Edit** Key before dialing.

To delete a name from the Callers List:



1. Press the **Callers List** Key.
2. **Scroll down** to the name you wish to delete.
3. Press the **Delete** Key.

If you do not push any buttons on your telephone for six seconds, the delete action will be ignored and the screen will display the directory entry again.



4. Press the **Delete** Key again to delete.

To delete the entire Callers List:



1. Press the **Callers List** Key.
2. Press the **Down-arrow** Key once.

A

A

Saving an entry from the Callers List to the Directory:



Program



To make a call from the Redial List:



Saving an entry from the Redial List to the Directory:



3. Press the **Delete** Key.

If you do not push any buttons on your telephone for six seconds, the delete action will be ignored and the screen will display the directory entry again.

4. Press the **Delete** Key again to delete.

1. Press the **Callers List** Key.

2. **Scroll down** to find the name or number.

3. Press the **Program** Key.

The name and number may be edited, if required, by pressing the **Edit** Key before saving.

The name and number are saved to the directory in alphabetical order.

1. Press the **Callers List** Key.

2. **Scroll up** to find the number.

3. When the number you wish to redial is displayed, press the **Dial** Key.

1. Press the **Callers List** Key.



Program

2. **Scroll up** to find the number.

3. Press the **Program** Key.

The number and name may be edited (using the **Edit** Key) before saving, if required.

The name and number are saved to the directory in alphabetical order.

Warning: Please be aware that any digits entered, including Authorization Codes and Passwords, will be stored in the Redial List.

Making a call

This chapter describes features that you can use when making a call.

Auto Dial

Auto Dial lets you dial a specific telephone number by pressing a feature key.

To store an Auto Dial number:

Auto Dial



Auto Dial

1. Without lifting the handset, press **Auto Dial**. The associated LCD Indicator flashes ►.
2. **Dial** the number.
3. Press **Auto Dial** again.

To use Auto Dial:



Auto Dial

1. **Lift the handset** or press a **DN** Key.
2. Press **Auto Dial**. The stored number is dialed automatically.

To display the Auto Dial number:

Display

Auto Dial

1. Press **Display**.
2. Press **Auto Dial**. The number is displayed.

Ring Again

If you receive a busy tone or the person does not answer when trying to reach someone in your office, or in your private network, Ring Again automatically redials that number and lets you know when that person is free, or that the person has used his set.

To use Ring Again:

Ring Again



1. You dial a DN and receive a busy tone or no answer. Press **Ring Again**.
2. **Replace the handset** or press **Release**.



Ring Again

To cancel Ring Again:

Ring Again

When the number you want to reach is free, or the person has re-used his set, you hear the Ring Again signal.

3. **Lift the handset** or press a **DN** Key.
4. Press **Ring Again** to automatically redial the number.

Press **Ring Again**.

Speed Call

Speed Call allows you to dial frequently-called telephone numbers using a brief code to represent the number. The codes are one, two, or three digits long (i.e. 000-999). See your telephone system administrator for a list of the Speed Call codes.

Only a telephone that has been designated as a Speed Call Controller telephone can program the numbers to be stored.

To store a Speed Call number:

Speed Call



Speed Call

1. Press **Speed Call**.
2. **Dial** the code to be added to the Speed Call list.
3. **Dial** the access code (if required), internal, external, or long-distance telephone number.
4. Press **Speed Call** again.

To change a Speed Call number:

Speed Call



1. Press **Speed Call**.
2. **Dial** the Speed Call code that you want to change.



Speed Call

To delete a Speed Call number:

Speed Call



Speed Call

To make a Speed Call:



Speed Call



Speed Call on Private Lines

To use Speed Call on Private Lines:

Private Line



Speed Call



3. **Dial** the new access code (if required), internal, external, or long-distance telephone number.

4. Press **Speed Call** again.

1. Press **Speed Call**.

2. **Dial** the Speed Call code that you want to delete.

3. Press **Asterisk**.

4. Press **Speed Call** again.

1. **Lift the handset** or press a **DN** Key.

2. Press **Speed Call**.

3. **Dial** the Speed Call code.

Speed Call on Private Lines allows you to access a Private Line trunk and make a speed call.

1. Press **Private Line**.

2. **Lift the handset** or press a **DN** Key.

3. Press **Speed Call**.

4. **Dial** the Speed Call code of the number you want to dial.

System Speed Call

System Speed Call lets you dial Speed Call codes and override all restrictions on the telephone during the call. See Speed Call for more information on setting up speed call codes.

To make a System Speed Call:



1. **Lift the handset** or press a **DN** Key.
2. Press **Sys Speed** Key.
3. **Dial** the Speed Call code of the number you want to dial.

Call Page

Call Page allows you to make an announcement over your paging system by dialing the page trunk access code.

Attendant consoles using the Page Key override telephones, which are then disconnected and must re-access the paging trunk.

To use the Call Page feature:



1. **Lift the handset** or press a **DN** Key.
2. **Dial** the paging trunk access code.
You are connected to the paging system.

To disconnect:



Replace the handset or press **Release**.

Override

You can override a busy signal and interrupt another call.

To override a busy/engaged signal:



Override

1. You **dial** a telephone number and hear busy signal.
2. Press **Override**. The people on the call in progress hear a tone for approximately one second; the three of you are then connected together. A short tone repeats.

Override, Enhanced

Enhanced Override allows you to override an ongoing call after you have attempted a Forced Camp-on. Use Enhanced Override when making either a simple call or a consultation call (i.e., place a call on hold and call another party).

To use Enhanced Override:



Override

Override

1. You **dial** a telephone number and hear a busy signal.
2. Press **Override** to initiate a Forced Camp-on. If any of the people on the call disconnects at this time, you receive a fast busy signal.
3. Press **Override**. The people on the call in progress hear a tone for approximately one second; the three of you are then connected together. A short tone repeats.

Stored Number

The Stored Number feature allows you to store a single telephone number that you can dial quickly. You can easily change the stored number.

To store a number when you're not on a call:

Stored No.



Stored No.

1. Without lifting the handset, press **Stored No.**
2. **Dial** the number.
3. Press **Stored No** again. Any number previously stored is replaced.

To store a number when you're on a call:

Stored No.

After you dial the number, press **Stored No.**

To display the stored number:

Display

Stored No.

1. Press **Display.**
2. Press **Stored No.** The number is displayed.

To call the stored number:



Stored No.

1. **Lift the handset** or press a **DN** Key.
2. Press **Stored No.**

Buzz

Two telephones may be linked, allowing one person to notify another person. The person to whom your telephone is linked hears a "buzz". Use this feature to indicate a call, a visitor, or a request.

To buzz the person whose telephone is linked to yours:

Buzz

Press **Buzz** The other telephone buzzes as long as you hold down the key.

Forced Camp-on

Forced Camp-on allows your telephone to automatically ring another telephone as soon as it disconnects from its current call. Forced Camp-on allows both internal and external calls to be camped on; Camp-on allows only external calls to be camped on.

To use Forced Camp-on:



Override



1. **Dial** a telephone number and hear a busy signal.
2. Press **Override** to initiate a Forced Camp-on. If either of the persons on the call disconnect at this time, you will hear a busy tone. People on the call will hear a tone and you will receive ringback.

When the person you are trying to reach ends the current call, their set will ring.

3. The person lifts the handset and the call is connected.

Call Charge/Forced Charge

Call Charge allows you to charge a call to a specific account. Forced Charge allows you to charge long distance calls from telephones that are restricted to local calls.

To charge a local or long distance call to an account before you dial:



Charge

or



1. **Lift the handset** or press a **DN** Key.
2. Press **Call Charge** or enter **FFC**.
3. **Dial** the charge account number.
4. Upon hearing dial tone, **Dial** your call.

To charge a call in progress:

or

or 



1. Press **Transfer** or **Conference**.
2. Press **Call Charge** or enter **FFC**.
3. **Dial** the charge account number.
4. Press the **DN** Key to return to your call.

To charge a call to an account when you transfer a call:

or 



1. Press **Transfer**. The call is on hold.
2. Press **Charge** or enter **FFC**.
3. **Dial** the charge account number.
4. When you hear dial tone, **Dial** the number you want the call transferred to.
5. Press **Transfer** when you hear ringing, or after you talk privately to the person you are transferring the call to.

To charge a call to an account when you add someone to a conference call:

or 



1. Press **Conference**. The call is on hold.
2. Press **Charge** or enter **FFC**.
3. **Dial** the charge account number.
4. **Dial** the party you want to add to the conference.
5. Press **Conference**.

Hot Line

The system administrator can program a Hot Line telephone number that is dialed automatically.

To use Hot Line:



Press **Hot Line**. The Hot Line number is dialed automatically.

or



If your main DN is a Hot Line, **Lift the handset**. The Hot Line number is dialed automatically.

Radio Paging

Your Meridian 1 system may be equipped with an on-site Radio Paging system. If you stay on the line, the paged person may answer the call by entering a special Paging “Meet - me” code from any DN.

Automatic Pre - selection (“Meet - me” paging).



Radio Paging Access

You wish to contact a person who is busy on a call or you wish to page someone without calling their DN. You wish to directly alert their radio paging device.

1. **Lift the handset** or press a **DN** Key.
2. **Dial** the Radio Paging **FFC**. You hear paging dial tone.
3. **Dial** the DN of the party to be paged. You hear ringback tone.

While ringback is heard, the person you have paged may proceed to any DN and enter a Radio Paging Answer code plus their own DN to be connected directly to you.

If your call is not answered within a pre-

Automatic Post - selection

Radio Page



Special Radio Paging Features

set time period you will hear a continuous high pitched tone for fifteen seconds, then silence. **Replace the handset** or press **Release** and try again later.

The called party is either busy on the telephone or away from the desk.

To page the called party there is no need to make a new call.

1. Press **Radio Page**. You hear special dial tone.
2. **Dial** the Radio Paging Access **FFC**. You hear ringback.

There is no need to redial the DN number of the called party in order to page them.

While ringback is heard, the person you have paged may proceed to any DN and enter a Radio Paging Answer code plus their own DN to be connected directly to you.

If your call is not answered within a pre-set time period you will hear a continuous high pitched tone for fifteen seconds, then silence. **Replace the handset** or press **Release** and try again later.

If you carry a Radio Pager, you will receive a paging indication when another telephone user accesses the Radio Paging system and dials your DN.

If the Radio Paging system is set up to function in "Meet - me" mode, you may answer the paging call from any DN and be connected to the person who has paged you.



1. **Lift the handset** or press a **DN** Key on any telephone on the system (as long as it is not a hotline, private line, or a manual line telephone). You hear dial tone.
2. **Dial** the Radio Paging Answer **FFC**. You hear paging tone.
3. **Dial** your own DN. You are connected to the paging caller. If the paging caller has hung up you will hear a steady high pitched tone (Number Unavailable tone).

Voice Call

You can page another person or make an announcement through another telephone's speaker.

To make a voice call:



Voice Call



1. **Lift the handset** or press a **DN** Key.
2. Press **Voice Call**.
3. Make your announcement.
4. **Replace the handset** or press **Release**.

To respond to a voice call:



Your telephone rings once and you hear the caller's voice through the speaker. **Lift the handset** or press a **DN** Key and begin speaking.

Receiving a call

This chapter describes features that you can use when receiving a call.

Call Waiting

If the attendant routes an outside call to you when you are already on a call, Call Waiting lets you put your current call on hold, allowing you to answer the outside call.

To answer an incoming call during a telephone call:

Hold

Call Wait

1. Press **Hold** when you hear a tone and the call waiting indicator flashes during a telephone call.
2. Press **Call Wait** to answer the incoming call.

To return to your first telephone call:

Hold or Rls

2637

1. Press **Hold** if you want to put the second call on hold, or **Release** to end the second call.
2. Press the **DN** Key associated with the first call.

To answer an incoming call during a telephone call without the Call Waiting Key:

Rls

2637

1. If you don't have a **Call Wait** Key and you hear the Call Waiting tone, end your current call and **Replace the handset** or press **Release**.
2. When the telephone rings, press the **DN** Key beside the flashing LCD indicator ► to answer the incoming call.

Call Pickup

Using Call Pickup, you can answer a ringing telephone from any telephone in your Pickup Group or another Pickup Group.

To answer a ringing call in your own Call Pickup group:



1. **Lift the handset** or press a **DN** Key.
2. Press **Call Pickup**, or enter the **FFC**.

To answer a ringing call in another Call Pickup group:

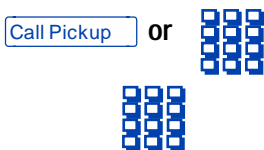

1. **Lift the handset** or press a **DN** Key.
2. Press **Call Pickup**, or enter the **FFC**.
3. **Dial** the pickup group number of the ringing telephone.

To answer a ringing call at a specific extension in any pickup group:

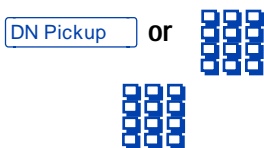

1. **Lift the handset** or press a **DN** Key.
2. Press **DN Pickup** or enter the **FFC**.
3. **Dial** the **DN** of the ringing telephone.

Timed Recall Reminder

Timed Reminder Recall rings your telephone after a period of time to remind you of a transferred call that has not yet been answered.

To use the Timed Reminder Recall:

Transfer



Transfer

1. Press **Transfer**. The call is placed on hold and you hear dial tone.
2. **Dial** the number to which you want to transfer the call.
3. When you hear ringback tone, press **Transfer** again.

If the transferred call is not answered, your telephone rings.

To Answer a recall:



Transfer

1. When your telephone rings, **Lift the handset** or press a **DN** Key. You are connected to the original caller.
2. Press **Transfer** to repeat the transfer, if desired.

Automatic Answerback

When Automatic Answerback is activated, your set automatically answers in Handsfree mode after one ring.

This feature is not supported on the M3110.

To activate Automatic Answerback:

Auto Ans

Press **Auto Ans**. The LCD indicator ► turns on.

When Automatic Answerback is active, calls are not routed to your voice message service, if provided.

To deactivate Automatic Answerback:

Auto Ans

Press **Auto Ans** again. The LCD Indicator ► turns off.

During a call

This chapter describes features that you can use during your call.

Call Transfer

Call Transfer allows you to transfer a call to another number.

To transfer a call while on a call:

Transfer



Transfer

1. Press **Transfer**. The call is placed on hold and you hear dial tone.
2. **Dial** the number to which you want to transfer the call.
3. Press **Transfer** again, either when you hear ringback, or after you talk privately to the person to whom you are transferring the call.

If the person you are calling is not available:

Rls

2637

1. Press **Release**.
2. Press the **DN** Key beside the flashing LCD indicator ►.

Auto Dial Transfer

Auto Dial Transfer allows you to use your Auto Dial Key to transmit digits to the central office after a Trunk Switchhook Flash. You must be on a central office/exchange (CO) trunk call from or to a CO which offers Centrex- or exchange line-type features.

To use Auto Dial Transfer when you pick up an incoming trunk call:

Trunk Switchhook Flash

Auto Dial



1. Press **Trunk Switchhook Flash** and wait for interrupted dial tone.
2. Press **Auto Dial** to call the number desired.
3. **Replace the handset** or press **Release** to end the call.

Call Park

Call Park allows a call to be held temporarily, then to be retrieved from any other **DN**. You can park a call and then page the called party, without tying up a line. Your office may have a System Park **DN** where most calls are automatically parked.

Call Park can be used if configured across networks.

To park a call on the System Park

Extension or your own **DN**:

Park

Park

Press **Park** twice. If there is a System Park **DN**, the call is parked on it. Otherwise, it is parked on your **DN**.

To park a call on a **DN** other than the System Park Extension or your own **DN**:

Park



Park

1. Press **Park**.
2. **Dial** the **DN**.
3. Press **Park** again.

To park a call using the **FFC**:

Transfer or Conference



Transfer or Conference

1. Press **Transfer** or **Conference**.
2. **Dial** the **FFC**.
3. If you don't want the System Park Extension or your own **DN**, **Dial** a **DN**.
4. Press **Transfer** or **Conference** again.

To retrieve a parked call:



Park

1. **Lift the handset** or press a **DN** Key.
2. Press **Park**, or enter the **FFC**.



3. **Dial** the **DN** where the call is parked.

If you park a call and it isn't answered within a specified period of time, it rings back to your telephone or to the attendant. Check with your system administrator about your specified period of time.

Attendant Recall

The Attendant Recall feature allows you to contact an attendant during a call and connect the call to the attendant.

To contact the attendant during a call:

Att Recall



1. Press **Attendant Recall** during a call.
2. Stay on the line until the attendant answers.
3. When you **Replace the handset or Press Release**, the caller remains connected to the attendant.

Display

When you are on an active call, you can identify a second incoming caller with the Display feature.

To view the name of a second caller while on a call in progress:

Display

2637

1. While on a call, you hear the call waiting tone.
2. Press **Display**.
3. Press the **DN** Key beside the flashing LCD indicator ►. Information about the call is displayed in the Display Module.

Displaying the second caller's name does not interfere with the current call in progress.

You can use the display key with other feature keys to display information associated with the feature keys.

Call Charge

With the Call Charge feature, you can create a charge account record and/or charge a call to an incoming number.

While on a call, to record the caller's number for accounting purposes:

Call Charge



Call Charge

1. Press **Call Charge**. You hear three beeps followed by dial tone. The other party is on hold.
2. **Dial** a charge account number or the caller's number.
3. Press **Call Charge** again to return to the call.

On Hold on Loudspeaker

The On Hold on Loudspeaker feature allows users such as commodities brokers to monitor one (with the optional Loudspeaker) or several (with the Speech Monitor) stock markets, for example, while talking to one or more customers using the handset. (A Speech Monitor works like a Loudspeaker, but can handle up to eight channels.) At any time, the user can enter the call being monitored on the Loudspeaker or Speech Monitor unit.

This feature requires additional equipment.

To use On Hold On Loudspeaker:

Hold

Loudspeaker

2637

1. Place the call on **Hold**.
2. Press **Loudspeaker**.
3. Press the **DN** Key associated with the call on hold. The call on hold is put on the Loudspeaker and is heard publicly.

To talk privately to the party on the Loudspeaker:

Use the handset on the Loudspeaker (if provided).

To use On Hold On Loudspeaker on the Speech Monitor:

Hot Line

Hold

While the Loudspeaker is active, any other call is maintained on the handset. More than one call can be put on hold, but only one call at a time can be placed on the Loudspeaker.

1. Make a call from **Hot Line** or the **DN** of the Speech Monitor.
2. Place the call on **Hold**. The Speech Monitor is automatically activated.

To talk privately to one of the parties on the Speech Monitor

Take the call on the handset of the phone.

This conversation will not be heard on the Loudspeaker. Any other user with a Speech Monitor DN on their set can enter the call by establishing a Multiple Appearance Conference.

To disconnect a call from the Speech Monitor:



Replace the handset or press **Release** while the call is active.

To disconnect from the Speech Monitor:

Switch off the Speech Monitor.

Malicious Call Trace

Malicious Call Trace provides a way for you to trace nuisance calls within your system.

While you are on a call:

Trace

Press **Trace**.

If you do not have a trace button:

Transfer

or

Conference



2637

1. Press **Transfer** or **Conference**.
2. **Dial** the Trace **FFC**.
3. Press the **DN** Key beside the flashing LCD indicator to return to the call.

Centrex/Exchange Switchhook Flash

Centrex/Exchange Switchhook Flash allows you to signal the Central Office/Exchange (CO) during an established call to use a Centrex service such as call transfer or three-way calling.

To use Centrex/Exchange Line Switchhook Flash:

Trunk Switchhook Flash



1. Press **Trunk Switchhook Flash**. You hear special dial tone.
2. **Dial** the codes for your custom Centrex feature.

While you are away from your desk

This chapter describes features that you may wish to use when you are away from your desk.

Call Forward

Call Forward allows you to transfer all your calls so that they ring at another **DN**. You cannot forward calls while your telephone is ringing.

To forward all your calls:

Forward



Forward

1. Press **Forward**. The LCD indicator ► flashes.
2. **Dial** the **DN** that you want to forward your calls to.
3. Press **Forward**. The LCD indicator ► remains on.

To cancel Call Forward:

Forward

Press **Forward**. The LCD indicator ► turns off.

To reinstate Call Forward to the same number:

Forward

Forward

Press **Forward** twice. The LCD indicator ► turns on again.

To display the number to which you are currently forwarding your internal calls (on telephones equipped with an appropriate display):

Display

Forward

1. Press **Display**.
2. Press **Forward**. The number is displayed.

You can forward calls to Meridian Mail by using the Meridian Mail DN as your Call Forward DN.

Call Forward - Internal

Call Forward—Internal allows only calls originating at internal DNs to ring at another DN. Calls originating outside your Meridian 1 system will still ring at your telephone. You cannot forward calls while your telephone is ringing.

To forward your internal calls:

Int Forward



Int Forward

1. Press **Internal Call Forward**. The LCD indicator ► flashes.
2. **Dial** the **DN** that you want to forward your calls to.
3. Press **Internal Call Forward**. The LCD indicator ► remains on.

To cancel Internal Call Forward:

Int Forward

Press **Internal Call Forward**. The LCD indicator ► turns off.

To reinstate Call Forward to the same number:

Int Forward

Int Forward

Press **Internal Call Forward** twice. The LCD indicator ► turns on again.

To display the number to which you are currently forwarding your internal calls (on telephones equipped with an appropriate display):

Display

Int Forward

1. Press **Display**.
2. Press **Internal Call Forward**. The number is displayed.

You can forward calls to Meridian Mail by using the Meridian Mail DN as your Call Forward DN.

Remote Call Forward

Remote Call Forward allows you (from any telephone other than your own) to forward your calls to any telephone.

To activate Remote Call Forward:



1. **Lift the handset** or press a **DN** Key.
2. If you are calling from a telephone outside the system, first **Dial** the Direct Inward System Access (DISA) number and wait for the dial tone.
3. **Dial** the Remote Call Forward Activate **FFC**.
4. **Dial** your Electronic Lock password. (See Electronic Lock on page 51.)
5. **Dial** your **DN**.
6. **Dial** the number of the telephone to which you want your calls forwarded. If the number you are forwarding calls to is invalid, you will hear a fast busy signal.
7. Press the **Octothorpe** Key.

If you want to forward calls to a previously programmed telephone number, skip step 6, above.

To cancel Remote Call Forward:



1. **Lift the handset** or press a **DN** Key.
2. If you are calling from a telephone outside the system, first **Dial** the Direct Inward System Access (DISA) number and wait for the dial tone.



3. Enter the Remote Call Forward Deactivate **FFC**.
4. **Dial** your Electronic Lock password. (See Electronic Lock on page 51.)
5. **Dial** your **DN**.
6. Press the **Octothorpe** Key.

To verify Remote Call Forward:



1. **Lift the handset** or press a **DN** Key.
2. If you are calling from a telephone outside the system, first **Dial** the Direct Inward System Access (DISA) number and wait for the dial tone.
3. Enter the Remote Call Forward Verify **FFC**.
4. **Dial** your Electronic Lock password. (See Electronic Lock on page 51.)
5. **Dial** your **DN**.
6. **Dial** the **DN** of the telephone you are forwarding to.
7. Press the **Octothorpe** Key.

Electronic Lock

You can lock your telephone with a password so that no one can make calls from your office. The lock consists of a password which you may change.

To lock your telephone:



1. **Lift the handset** or press a **DN** Key.
2. **Dial** the Lock **FFC**.
3. **Dial** your electronic lock password.
4. If you are using someone else's telephone, **Dial** your **DN**.
5. **Replace the handset** or press **Release**.

To unlock your telephone:



1. **Lift the handset** or press a **DN** Key.
2. **Dial** the Unlock **FFC**.
3. **Dial** your electronic lock password.
4. If you are using someone else's telephone, **Dial** your **DN**.
5. **Replace the handset** or press **Release**.

To change your electronic lock password:



1. **Lift the handset** or press a **DN** Key.
2. **Dial** the password Change **FFC**.
3. **Dial** the current password for your telephone.



If you hear a fast busy signal you may have misdialed:



4. **Dial** the new password you wish to use.
5. **Dial** the new password again.

Replace the handset or press **Release** and try again.

You can only change your password from your telephone. Password change is not supported from a remote set.

Intercom

You can use the Intercom feature to call a member of your intercom group.

To make an Intercom call:



1. **Lift the handset** or press a **DN** Key.
2. Press **Intercom**.
3. **Dial** the one- or two-digit code for the intercom group member you wish to call.

To answer an intercom call when you are on a line other than your intercom group line:

Hold or **Rls**

Intercom

1. Press **Hold** to put the current call on hold, or press **Release** to terminate the call.
2. Press **Intercom** and begin speaking.

To talk with more than one person

This chapter describes features which allow you to talk with more than one person at the same time.

Conference

You can set up a conference call for up to three (or six) people, including yourself. Contact your telephone system administrator to find out the maximum number of persons you can join in a conference call on your system.

To set up a conference call:

Conference



Conference

1. While on a call, press **Conference**. The other party is on hold and you hear dial tone.
2. **Dial** the next number to add to the conference. When the call is answered, you may talk privately with the person before they join the conference.
3. Press **Conference** again to join all callers.

If necessary, repeat the procedure to include up to six people in the conference.

If the person you are adding to the conference is not available:

Rls

2637

1. Press **Release**.
2. Press the **DN** Key with the flashing LCD indicator to return to your original call.

Group Call

Group Call automatically calls members of a predefined group, one at a time, until they have all answered. Ask your system administrator for details on creating a conference call group.

To call group members:



Group Call

1. **Lift the handset** or press a **DN** Key.
2. Press **Group Call**. The group members are called automatically. The LCD indicator ► beside the Group Call Key flashes until all members have answered.

Their phone numbers appear on the display as they answer. When the last person answers, the Group Call indicator lights steadily.

When a person in your group is on another call on the DN the incoming group call is on, the group call is put in Camp-on or Call Waiting mode.

When a person in your group is on a conference call or another group call, he or she is not connected to your group call.

After all the people in the group have answered, only the person who made the group call can put the call on hold.

To answer a Group Call:



Lift the handset or press a **DN** Key.

If you are on a call and you hear three 10-second tones through the handset or speaker, you are being notified of an incoming group call on your current DN.

If you are on a call on another telephone in your group when a group call is made, you hear a long tone through the handset or speaker.

If you are on a conference call or a group call when another group call comes in, you are not notified of the second call.

To end a Group Call:



Replace the handset or press **Release**.

When the person who made the group call disconnects, all the members of the group are disconnected from the call. However, the other members can disconnect at any time during the call without affecting the call.

Call Join

To connect a call on hold (on a different line) to your current call:

Conference

Conference

1. You are currently on a call.
2. Press **Conference**.
3. Press the key that has the other call on it, e.g. **Call Wait**.
4. Press **Conference**.

The person on hold joins your conversation.

Privacy Release

Privacy Release allows one or more people who share your DN to join your call.

To use Privacy Release:

Priv Rls

Press **Privacy Release** during a call. One person can now join in by pressing the **DN** Key beside the flashing **Feature** Key.

Repeat Step 1 above to join additional appearances of the DN.

Working without interruption

This chapter describes features that allow you to avoid receiving calls.

Call Forward

Call Forward allows you to transfer all your calls so that they ring at another **DN**. You cannot forward calls while your telephone is ringing.

To forward all your calls:

Forward



Forward

1. Press **Forward**. The LCD indicator ► flashes.
2. **Dial** the **DN** that you want to forward your calls to.
3. Press **Forward**. The LCD indicator ► remains on.

To cancel Call Forward:

Forward

Press **Forward**. The LCD indicator ► turns off.

To reinstate Call Forward to the same number:

Forward

Forward

Press **Forward** twice. The LCD indicator ► turns on again.

To display the number to which you are currently forwarding your internal calls (on telephones equipped with an appropriate display):

Display

Forward

Display

1. Press **Display**.
2. Press **Forward**. The number is displayed.
3. If you want to clear the display, press **Display** again.

You can forward calls to Meridian Mail by using the Meridian Mail DN as your Call Forward DN.

Make Busy

Make Busy allows you to make your telephone appear busy to all callers.

To make your telephone appear busy:

Make Busy

Press **Make Busy**. The LCD indicator is lit.

To receive calls again:

Make Busy

Press **Make Busy** again. The LCD indicator turns off.

Hospitality features

These hospitality features are intended for hotel operations use.

Automatic Wake-Up

Although normally used as a hotel feature, Automatic Wake-up may be useful to business users who require a timed reminder call feature. From your telephone you may program the Meridian 1 system to automatically place a call to you at a predetermined time. When you answer the call, you will hear recorded music for up to thirty seconds followed by a prerecorded announcement, or the attendant.

To enter the time for a wake-up call:



1. **Lift the handset** or press a **DN** Key.
2. **Dial** the Wake-Up Request **FFC**.
3. **Dial** the wake-up time in a 24-hour format (hh mm).
4. **Replace the handset** or press **Release**.

To cancel a wake-up call:



1. **Lift the handset** or press a **DN** Key.
2. **Dial** the Wake-Up Cancel **FFC**.
3. **Replace the handset** or press **Release**.

To verify the time for the wake-up call:



1. **Lift the handset** or press a **DN** Key.
2. **Dial** the Wake-Up Verify **FFC**.

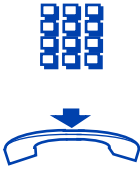

3. **Dial** the wake-up time in a 24 hour format (hh mm). If it is correct, you hear a confirmation tone.
4. **Replace the handset** or press **Release**.

In 24-hour format, 7:30 AM is entered as 0730; 9:45 PM is 2145.

Message Registration

If your telephone is equipped with a display, you can read, change, or reset meters that log hotel telephone calls.

To read meters:



1. Press **Message Registration**.
2. **Dial** the room **DN**.
3. Press **Message Registration** again.

To change a meter:



1. Press **Message Registration**.
2. **Dial** the room **DN**.
3. **Dial** the correct meter count.
4. Press **Asterisk**.
5. Press **Message Registration**.

To reset a meter to zero:



1. Press **Message Registration**.
 2. **Dial** the room **DN** number.
 3. Press **Asterisk**.
- Press **Message Registration**.

Maid Identification

Maid ID makes it easier to keep track of which maids clean which rooms. The maid enters the information from the telephone in each room.

To enter cleaning status:



1. **Lift the handset** or press a **DN** Key.
2. **Dial the FFC.**
3. **Dial** one of the following cleaning status codes:
 - 1** = cleaning requested
 - 2** = cleaning in progress
 - 3** = room cleaned
 - 4** = room passed inspection
 - 5** = room failed inspection
 - 6** = cleaning skipped
 - 7** = not for sale

You hear interrupted dial tone.



4. Press **Asterisk**.
5. **Dial** the Maid ID. If you enter the wrong Maid ID, press **Octothorpe** and then reenter the ID.
6. Press **Octothorpe**.
7. **Replace the handset** or press **Release**.

Room Status

Room Status lets you read the status of a room using the Display Module.

To read the status of a room:

Status



1. Press **Status**.
2. **Dial** the **DN** for the room. The **DN** is displayed followed by a two-digit code.

The first digit indicates the occupancy status:

- 0 = room vacant
- 1 = room occupied

The next digit indicates the cleaning status of the room:

- 1 = cleaning requested
- 2 = cleaning in progress
- 3 = room cleaned
- 4 = room passed inspection
- 5 = room failed inspection
- 6 = cleaning skipped
- 7 = not for sale

Status

3. Press **Status** again.

To change the status of a room:



1. Press **Status**.
2. **Dial** the **DN** for the room. The **DN** is displayed followed by a two-digit code.

The first digit indicates the occupancy status:

- 0 = room vacant
- 1 = room occupied

The next digit indicates the cleaning status of the room:

- 1 = cleaning requested
- 2 = cleaning in progress
- 3 = room cleaned
- 4 = room passed inspection
- 5 = room failed inspection
- 6 = cleaning skipped
- 7 = not for sale



3. **Dial** the status code you want to assign to the room. A three-digit code appears. The first digit indicates the occupancy status. The second digit is the old cleaning status, and the third is the new cleaning status you just entered.
4. Press **Status** again.

Options

Optional items are available for use with your Orion telephone. Please contact your System Administrator for further details.

Key Expansion Module

The Key Expansion Module provides 22 additional feature keys for the M3820. You can add up to two Key Expansion modules, for a total of 57 feature keys.

External Alerter Interface

The External Alerter Interface lets you connect a remote ringer to your telephone. It can be used with all three models. The remote ringer is provided by your supplier.

Meridian Communications Adapter (MCA)

The MCA lets you connect your telephone to a personal computer or terminal. You can then use your telephone to exchange data between your computer and other computers. The MCA can be used with all three models.

Your Telephone's Controls

The numbers appearing to the left of each icon below correspond to the illustration near the beginning of the chapter "Introducing your Meridian Digital Telephone" in this book.





Use the **Volume Control Bar** to control the volume of the handset/headset, speaker, ringer, buzzer and handsfree. Raise the volume by pressing the right side of the bar. Lower it by pressing the left side.



You can terminate an active call by pressing **Release**, or by hanging up the handset. **Release** is especially useful for disconnecting Handsfree calls.



A steady LCD indicator() appearing beside a **Feature** Key means that the feature or line beside it is active. A flashing  means the line is on hold or the feature is being programmed.



By pressing **Hold**, you can put an active call on hold. Return to the caller by pressing the **DN** Key beside the flashing .



The **Speaker** Key allows you to activate the handsfree and group listening features. Handsfree is enabled by the system administrator. (M3820 and M3810)



While on a call, you can press the **Mute** Key. The party(ies) to whom you are speaking cannot hear you. This is especially useful when on a conference call and you are only listening. When you wish to return to the two-way conversation, push the **Mute** Key again. The **Mute** Key applies to handsfree, handset and headset microphones. The speaker/mute LED lights when Handsfree or Group

17



Listening is active and flashes quickly when the Mute option is in use.

The **Dial** Key functions much like the primary Directory Number (**DN**) Key. The **Dial** Key is used to dial numbers stored in the Directory and Callers List. (M3820 only).

19



The **Cursor** Keys allow you to scroll through the Directory and Callers List. (M3820 and M3810)

9



The **Edit** Key is the key marked with an "E" and is used to edit Directory and Callers List entries. (M3820 only.)

16



The **Delete** Key is located under the primary **DN** Key. This key is used for deleting entries in the Directory and Callers List. (M3820 only.)

18



The **Directory** Key allows you to access a 75 entry personal Directory. (M3820 only.)

10



The **Callers** Key allows you to see the previous 20 incoming calls and last 5 outgoing calls. (M3820 only.)

15



The lower right-hand feature key is the **Prime Directory Number (DN) Key**. When you pick up the handset, the line associated with this key is ready for you to make a call. You may have more than one DN Key assigned to your telephone.

14



The **Program** Key allows you to access and modify telephone options via the display. On the M3820, the **Program** Key can be used as a **Save** Key when entering names in to your Directory. (M3820 and M3310)

Terms you should know

Attendant — the attendant is a telephone operator in your organization.

Directory Number (DN) — a DN is any extension on a telephone.

Flexible Feature Codes (FFCs) — your system may use FFCs to access some of your telephone's features. For your convenience, the FFCs for your system can be printed on a page located at the back of this guide.

Meridian 1 — the Meridian 1 is your office communications system.

Private Line — a Private Line may be assigned to your telephone. With this line, you may reach any outside number without dialing the digit(s) which you normally use to get an outside line. Internal extensions cannot be dialed from a private line.

Paging tone — tone heard when using the Radio Paging feature. You hear two beeps followed by dial tone.

Primary Directory Number (DN) Key — the key on your telephone which corresponds to the main number for the telephone.

Ringback/ring tone — ringback/ring tone is the sound you hear when a call you've made is ringing at its destination.

Interrupted dial tone — a broken, or pulsed dial tone that you will hear when accessing some of your telephone's features.

Special dial tone — three consecutive tones followed by dial tone that you will hear when accessing some of your telephone's features.

Shared Directory Numbers — a DN (extension) that is shared by two or more persons.

Switchhook — the switchhook is the button which the handset presses down, disconnecting your call when you replace the handset.

FFCs

	Radio Paging		Lock
	Radio Paging Access		Unlock
	Radio Paging Answer		Call Pick Up
	Call Park		DN Pick Up
	Electronic Lock Password Change		Group Pick Up
	Maid ID		Remote Call Forward Activate
	Wake-Up Request		Remote Call Forward Verify
	Wake-Up Verify		Remote Call Forward Deactivate
	Wake-Up Cancel		Trace

A

Attendant 67

Attendant Recall 43

Auto Dial

display number 25

store number 25

use 25

Auto Dial Transfer 41

Automatic Answerback

activate 39

deactivate 39

Automatic Wake-Up

cancel 59

enter time 59

verify time 59

B

Buzz 30

C

Call Charge

charge a call before dialing 31

charge a transfer call 32

charge an addition to a conference call 32

charge in progress call 32, 44

Call Forward

cancel 47, 57

display number 47, 57

forward calls 47, 57

reinstate 47, 57

Call Forward - Internal

cancel 48

display number 48

forward calls 48

reinstate 48

Call Join 55

Call Page

disconnect 28

use 28

Call Park

park call on a DN 42

park call on own DN 42

park call on System Park Extension 42

retrieve a parked call 42

using the FFC 42

Call Pickup

answer a ringing call in another Call Pickup group 38

answer a specific call in any Call Pickup group 38

answer call in your own Call Pickup group 38

Call Timer Enable 10

Call Transfer 14, 41

Call Waiting

answer incoming call with key 37

answer incoming call without key 37

return to first call 37

Callers List 7

- delete 22
- delete name from 22
- disable flashing LCD 21
- enable flashing LCD 21
- make call from 22
- save entry to Directory 23
- specify type of incoming call to save 21
- view 22

Callers Saved 8

Camp-on, Forced 31

Centrex Switchhook Flash 46

Conference 53

Contrast Adjustment 9

Controls, telephone 5, 65

D

Delete Directory 8

Dial tone

- interrupted 67

- special 67

Direct Inward System Access 49, 50

Directory

- delete 8

- deleting 20

- deleting items 19

- editing 20

- entering items 18

- finding items 19

- making a call from 20
- save entry from Callers List 23
- save entry from Redial List 23

Directory Number 67

Display

- Auto Dial number 25
- Call Forward number 47, 48, 57
- second caller while on a call 43
- Stored Number 30

Display Diagnostics 11

DN 67

E

Electronic Lock

- change password 51
- lock your telephone 51
- unlock your telephone 51

Enhanced Override 29

Exchange Switchhook Flash 46

External Alerter Interface 64

F

Features, telephone 12

Forced Camp-on 31

Forced Charge

- charge a call before dialing 31
- charge a transfer call 32
- charge an addition to a conference call 32

charge in progress call 32

G

Group Call

answer 54

call members 54

end 55

Group Listening 7

activate 17

disable 18

enable 18

mute a call 17

switch loudspeaker off 17

switch to Handsfree 18

H

Handsfree

discontinue using 16

mute a call 17

switch from Group Listening 18

switch from handset 17

using 16

Hold 13

Hot Line 33

I

Idle Screen Format 10

Initiating Calls 12

Intercom

answer Intercom call 52

make a call 52

Interrupted dial tone 67

K

Key Click 11

Key Expansion Module 64

L

Language Selection 11

Last Number Redial 16

M

Maid Identification

enter cleaning status 61

Make Busy 58

Malicious Call Trace

with Trace button 46

without Trace button 46

Meridian 1 67

Meridian Communications Adapter 64

Message Registration

change meter 60

read meters 60

reset meter 60

O

On Hold on Loudspeaker

disconnect 45

talk privately to party on Speech Monitor 45

- talk privately to party on the Loudspeaker 44
- use 44
- use with Speech Monitor 45

On-hook dialing 15

Options 64

Override 29

Override, Enhanced 29

P

Paging tone 67

Predial 15

Predial Recall 9

Primary Directory Number (DN) key 67

Privacy Release 56

Private Line 67

R

Radio Paging

- post-selection 34

- pre-selection 33

- special features 34

Redial List

- disable flashing LCD 21

- enable flashing LCD 21

- make call from 23

- save entry to Directory 23

- view 22

Remote Call Forward

- activate 49

cancel 49

verify 50

Ring Again

cancel 26

use 25

Ringback/ring tone 67

Room Status

change status 63

read status 62

S

Shared Directory Numbers 67

Special dial tone 67

Speed Call

change number 26

delete number 27

make a call 27

store number 26

Speed Call on Private Lines

make a call 27

Stored Number

display number 30

store a number 30

use 30

Switchhook 67

System Speed Call

make a call 28

T

Telephone controls 5

Timed Recall Reminder

 answer recall 39

 use 39

V

Voice Call

 make a call 35

 respond 35

Volume adjustment 9