

# **Face Recognition Access Controller**

## **Quick Start Guide**







# Foreword

## General

This manual introduces the installation and basic operations of the Face Recognition Access Controller (hereinafter referred to as "access controller").

## Safety Instructions

The following categorized signal words with defined meaning might appear in the manual.

Signal Words	Meaning
 <b>DANGER</b>	Indicates a high potential hazard which, if not avoided, will result in death or serious injury.
 <b>WARNING</b>	Indicates a medium or low potential hazard which, if not avoided, could result in slight or moderate injury.
 <b>CAUTION</b>	Indicates a potential risk which, if not avoided, could result in property damage, data loss, lower performance, or unpredictable result.
 <b>TIPS</b>	Provides methods to help you solve a problem or save you time.
 <b>NOTE</b>	Provides additional information as the emphasis and supplement to the text.

## Revision History

Version	Revision Content	Release Time
V1.0.1	Updated the manual.	October 2022
V1.0.0	First release.	July 2020

## About the Manual

- The manual is for reference only. If there is inconsistency between the manual and the actual product, the actual product shall prevail.
- We are not liable for any loss caused by the operations that do not comply with the manual.
- The manual would be updated according to the latest laws and regulations of related regions. For detailed information, see the paper manual, CD-ROM, QR code or our official website. If there is inconsistency between paper manual and the electronic version, the electronic version shall prevail.
- All the designs and software are subject to change without prior written notice. The product updates might cause some differences between the actual product and the manual. Please contact the customer service for the latest program and supplementary documentation.
- There still might be deviation in technical data, functions and operations description, or errors in

print. If there is any doubt or dispute, please refer to our final explanation.

- Upgrade the reader software or try other mainstream reader software if the manual (in PDF format) cannot be opened.
- All trademarks, registered trademarks and the company names in the manual are the properties of their respective owners.
- Please visit our website, contact the supplier or customer service if there is any problem occurred when using the device.
- If there is any uncertainty or controversy, please refer to our final explanation.

# Important Safeguards and Warnings

This chapter describes the contents covering proper handling of the access controller, hazard prevention, and prevention of property damage. Read these contents carefully before using the access controller, comply with them when using, and keep the manual well for future reference.

## Operation Requirements

- Do not place or install the access controller in a place exposed to sunlight or near the heat source.
- Keep the access controller away from dampness, dust or soot.
- Keep the access controller installed horizontally on the stable place to prevent it from falling.
- Do not drop or splash liquid onto the access controller, and make sure that there is no object filled with liquid on the access controller to prevent liquid from flowing into the access controller.
- Install the access controller in a well-ventilated place, and do not block the ventilation of the access controller.
- Operate the access controller within the rated range of power input and output.
- Do not disassemble the access controller randomly.
- For the access controller with a temperature monitoring unit:
  - ◇ Install the temperature monitoring unit in a windless indoor environment, and maintain the indoor ambient temperature at 15°C to 32°C.
  - ◇ Warm up the temperature monitoring unit for more than 20 minutes after power-on to enable the temperature monitoring unit to reach thermal equilibrium.

## Electrical Safety

- Improper battery use might result in fire, explosion, or inflammation.
- When replacing battery, make sure the same model is used.
- Use the recommended power cables in the region and conform to the rated power specification.
- Use the power adapter provided with the access controller; otherwise, it might result in people injury and device damage.
- The power source shall conform to the requirement of the Safety Extra Low Voltage (SELV) standard, and supply power with rated voltage which conforms to Limited power Source requirement according to IEC60950-1. Please note that the power supply requirement is subject to the device label.
- Connect the device (I-type structure) to the power socket with protective earthing.
- The appliance coupler is a disconnection device. When using the coupler, keep the angle for easy operation.

# Table of Contents

<b>Foreword</b> .....	<b>I</b>
<b>Important Safeguards and Warnings</b> .....	<b>III</b>
<b>1 Dimensions and Components</b> .....	<b>1</b>
<b>2 Connection and Installation</b> .....	<b>3</b>
2.1 Cable Connection .....	3
2.2 Installation Notes .....	4
2.3 Installation .....	5
<b>3 System Operations</b> .....	<b>8</b>
3.1 Initialization.....	8
3.2 Adding New Users .....	8
<b>4 Web Operations</b> .....	<b>11</b>
<b>Appendix 1 Notes of Temperature Monitoring</b> .....	<b>12</b>
<b>Appendix 2 Notes of Face Recording/Comparison</b> .....	<b>13</b>
<b>Appendix 3 Cybersecurity Recommendations</b> .....	<b>16</b>

# 1 Dimensions and Components

Figure 1-1 Dimensions and components of model X (mm [inch])

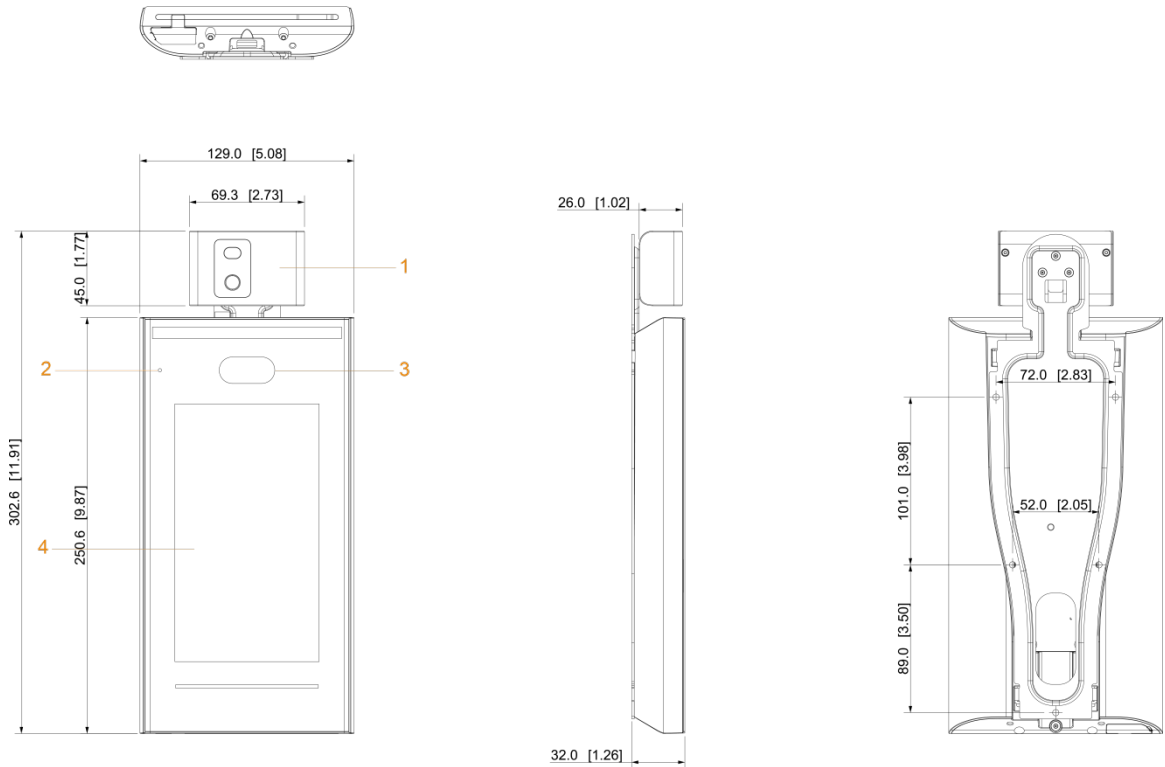

Table 1-1 Component description (1)

No.	Name	No.	Name
1	Temperature monitoring unit	3	Dual cameras
2	MIC	4	Display

Figure 1-2 Dimensions and components of model Y (mm [inch])

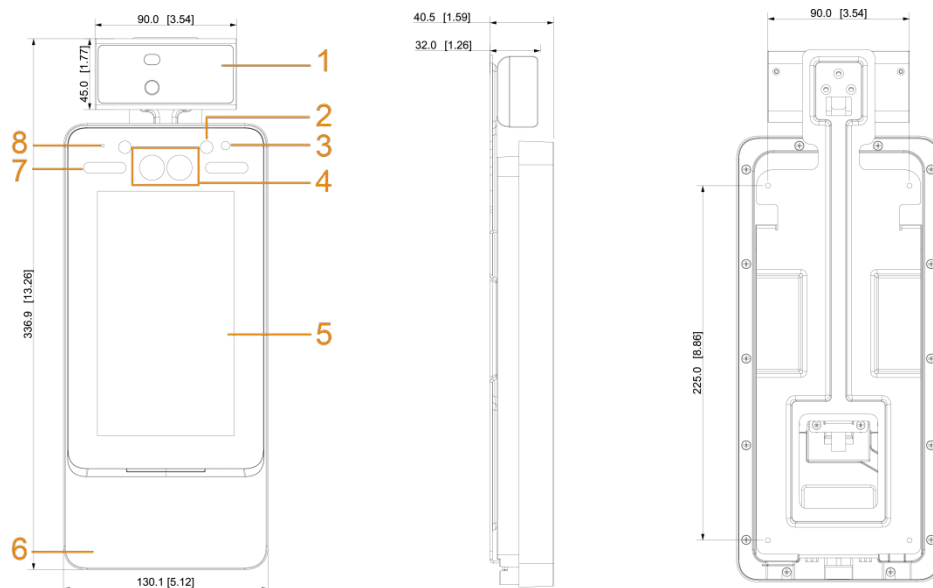

Table 1-2 Component description (2)

No.	Name	No.	Name
1	Temperature monitoring unit	5	Display
2	IR light	6	Card swiping area

<b>No.</b>	<b>Name</b>	<b>No.</b>	<b>Name</b>
3	Phototransistor	7	White LED illuminator
4	Dual cameras	8	Mic

# 2 Connection and Installation

## 2.1 Cable Connection

The cable connection of model X and model Y is the same. This section takes the model X as an example.



- Check whether the access control security module is enabled in **Function > Security Module**. If enabled, you need to purchase access control security module separately. The security module needs separate power supply.
- Once the security module is enabled, the exit button, lock control and firefighting linkage will be invalid.

Figure 2-1 Cable connection

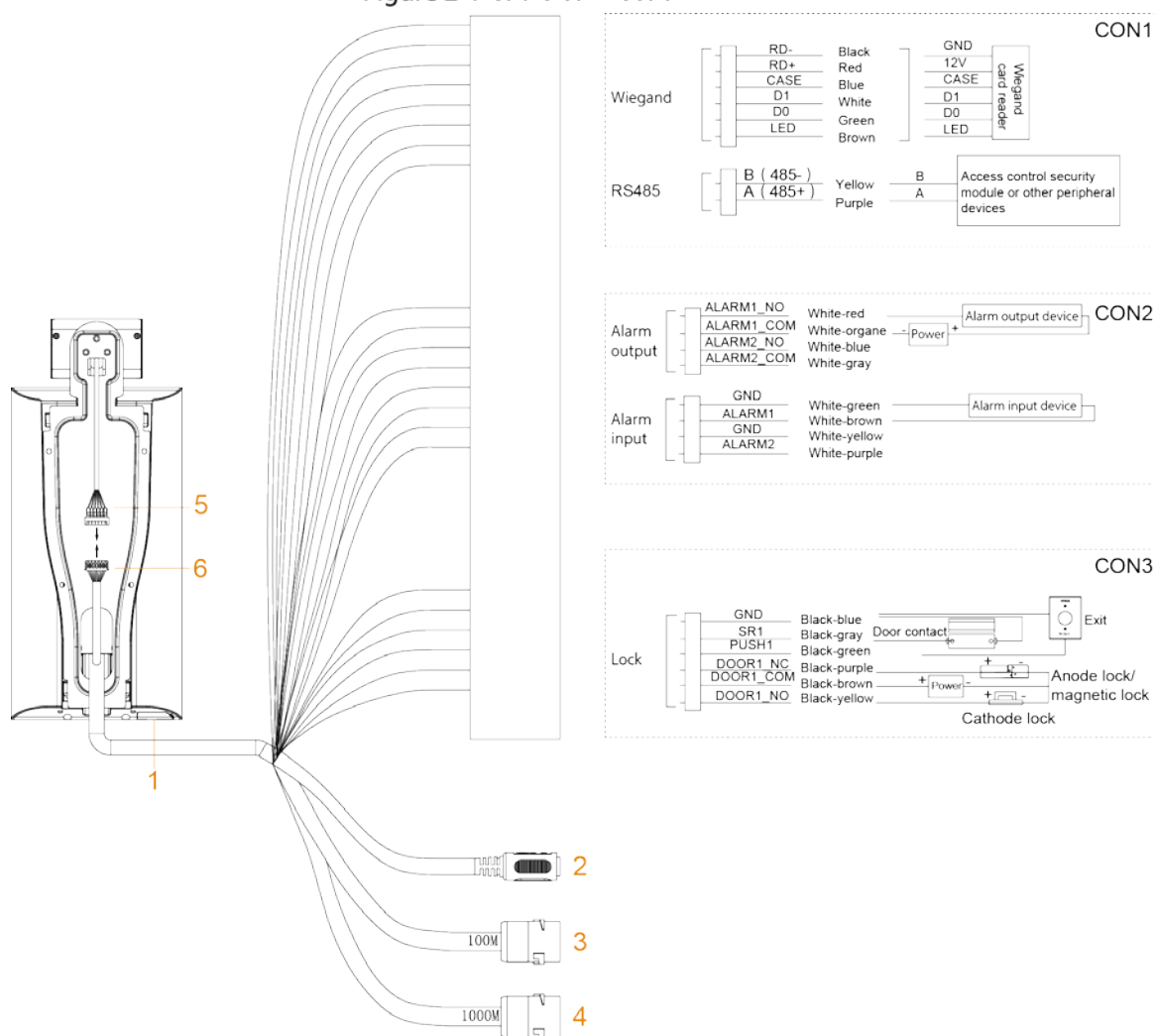

Table 2-1 Component description

No.	Name
1	USB port
2	Power port
3	100M network port



No.	Name
4	1000M network port (only supported by 7-inch access controllers of model X)
5, 6	Ports for connecting the temperature monitoring unit

## 2.2 Installation Notes



- If there is light source 0.5 meters away from the access controller, the minimum illumination should be no less than 100 Lux.
- It is recommended that the access controller is installed indoors, at least 3 meters away from windows and doors and 2 meters away from lights.
- Avoid backlight and direct sunlight.

### Ambient Illumination Requirement

Figure 2-2 Ambient illumination requirement



Candle: 10Lux



Light bulb: 100Lux–850Lux



Sunlight:  $\geq 1200\text{Lux}$

### Temperature Monitoring Requirement

- It is recommended to install the temperature monitoring unit in an indoor windless environment (a relatively isolated area from the outdoor), and maintain the ambient temperature at 15°C to 32°C.
- Warm up the temperature monitoring unit for more than 20 minutes after power-on to enable the temperature monitoring unit to reach thermal equilibrium.
- If there is no suitable indoor environment (including areas directly facing indoor and outdoor areas, and outdoor doorways), set up a temporary passage with stable ambient temperature for temperature monitoring.
- The factors such as sunlight, wind, cold air, and air conditioning cold and warm air can easily affect the surface temperature of human body and the working status of the access controller, which will cause the temperature deviation between the monitored temperature and the actual temperature.
- Influencing factors of temperature monitoring
  - ◇ Wind: Wind will take away the heat from the forehead, which will affect the accuracy of temperature monitoring.
  - ◇ Sweating: Sweating is a way for the body to automatically cool down and dissipate heat. When the body sweats, the temperature will also decrease.
  - ◇ Room temperature: If the room temperature is low, the surface temperature of human body will decrease. If the room temperature is too high, the human body will start to sweat, which will affect the accuracy of temperature monitoring.
  - ◇ The temperature monitoring unit is sensitive to light waves with a wavelength of 10um to

15um. Avoid using it in the sun, fluorescent light sources, air conditioning outlets, heating, cold air outlets, and glass surfaces.

## Places Recommended

Figure 2-3 Places recommended

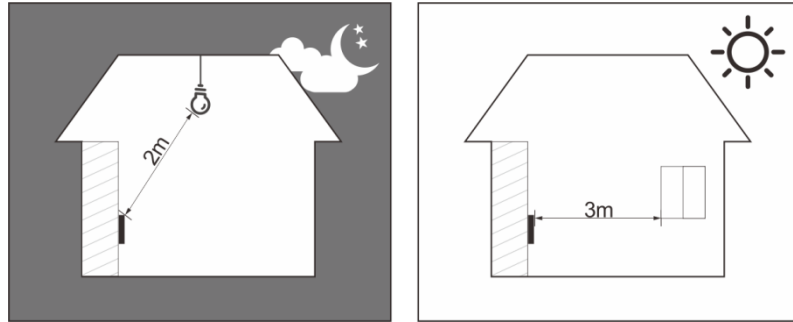

## Places Not Recommended

Figure 2-4 Places not recommended

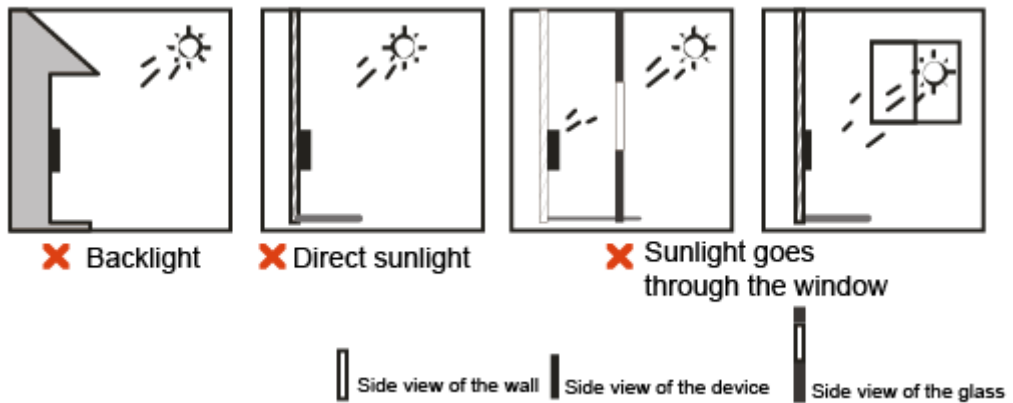

## 2.3 Installation

The installation of model X and model Y is the same. This section takes model X as an example. Make sure that the distance between the lens and ground is 1.4 meters.

Figure 2-5 Installation height

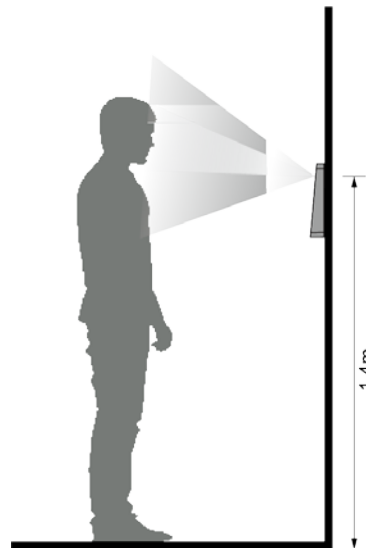
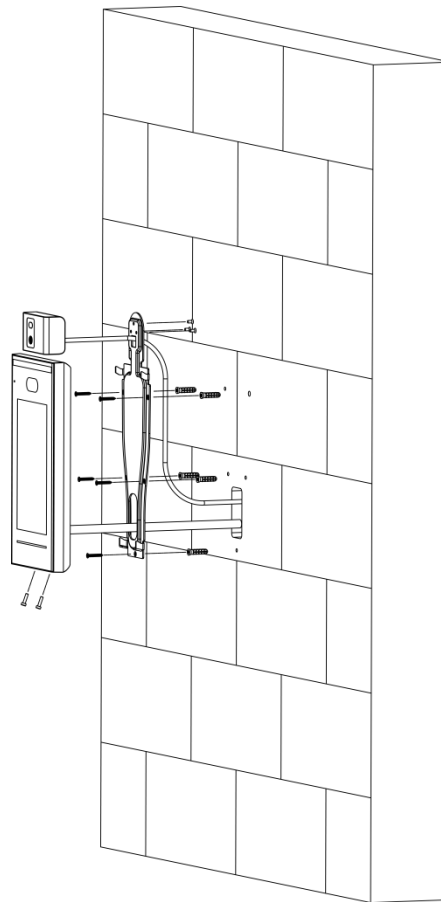

Figure 2-6 Installation diagram



## Installation Procedure

- Step 1** Fix the temperature monitoring unit to the bracket with 3 screws (only required by the access controller with a temperature monitoring unit).
- Step 2** Drill six holes (five bracket installation holes and one cable entry) in the wall according to holes in the bracket.
- Step 3** Fix the bracket on the wall by installing the expansion screws into the five bracket installation holes.

- Step 4** Connect cables for access controller. See "2.2 Cable Connections."
- Step 5** Hang the access controller on the bracket hook.
- Step 6** Tighten the screws at the bottom of the access controller.
- Step 7** Apply silicon sealant to the cable outlet of the access controller.

Figure 2-7 Applying silicon sealant

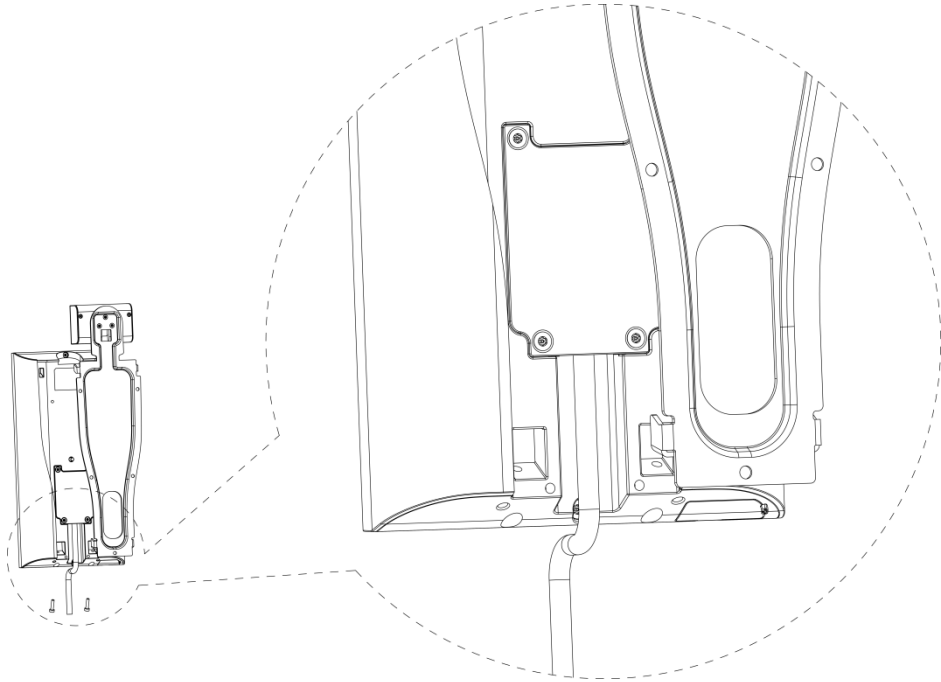

# 3 System Operations

## 3.1 Initialization

Administrator password and an email should be set the first time the access controller is turned on; otherwise the access controller cannot be used.

Figure 3-1 Initialization

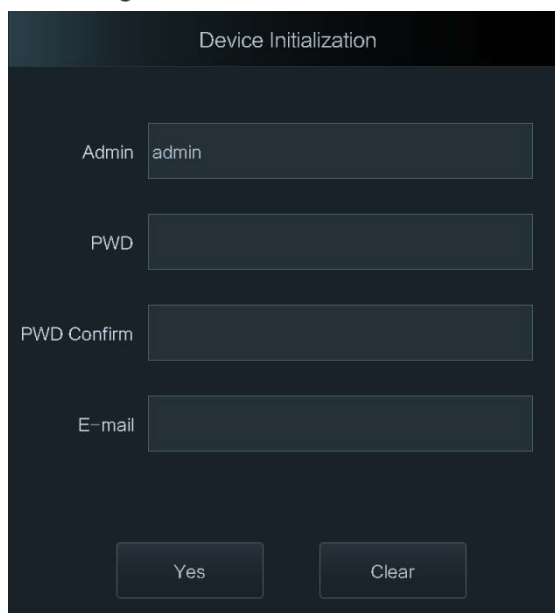

The screenshot shows a 'Device Initialization' screen with the following fields and buttons:

- Admin: admin
- PWD: [Empty]
- PWD Confirm: [Empty]
- E-mail: [Empty]
- Buttons: Yes, Clear



- The administrator password can be reset through the email address that you entered if the password is forgotten.
- The password must consist of 8 to 32 non-blank characters and contain at least two types of characters among upper case, lower case, number, and special character (excluding ' " ; : &).
- For access controller without touch screen, initialize through the web interface. See the user manual for details.

## 3.2 Adding New Users

You can add new users by entering user IDs, names, importing fingerprints, face images, passwords, and selecting user levels.



The following figures are for reference only, and the actual interface shall prevail.

Step 1 Select **User > New User**.



Figure 3-2 New user



**Step 2** Configure parameters on the interface.

Table 3-1 New user parameter description

Parameter	Description
User ID	Enter user IDs. The IDs consist of 32 characters (including numbers and letters), and each ID is unique.
Name	Enter names with at most 32 characters (including numbers, symbols, and letters).
Face	Make sure that your face is centered on the picture capturing frame, and then a picture of your face will be automatically captured. For details about face image recording, see "Appendix 2 Notes of Face Recording/Comparison."
Card	<p>You can register at most five cards for each user. On the card registration interface, enter your card number or swipe your card, and then the card information will be read by the access controller.</p> <p>You can enable the Duress Card function on the card registration interface. Alarms will be triggered if a duress card is used to unlock the door.</p> <p> If the access controller is without card reading module, you need to connect the device to peripheral card readers.</p>

Parameter	Description
PWD	<p>The door unlocking password. The maximum length of the password is 8 digits.</p>  <p>If the access controller is without touch screen, you need to connect the access controller to a peripheral card reader. There are buttons on the card reader.</p>
Level	<p>You can select a user level for new users. There are two options.</p> <ul style="list-style-type: none"> <li>● User: Users only have door unlock permission.</li> <li>● Admin: Administrators can unlock the door and also have parameter configuration permission.</li> </ul>  <p>In case that you forget the administrator password, you had better create more than one administrator.</p>
Period	The period in which the user can unlock the door. For detailed period settings, see the user manual.
Holiday Plan	You can set a holiday plan in which the user can unlock the door. For detailed holiday plan settings, see the user manual.
Valid Date	You can set a period during which the unlocking information of the user is valid.
User Level	<p>There are six levels:</p> <ul style="list-style-type: none"> <li>● General: General users can unlock the door normally.</li> <li>● Blocklist: When users in the blocklist unlock the door, service personnel will get a prompt.</li> <li>● Guest: Guests are allowed to unlock the door certain times in certain periods. Once they exceed the maximum times and periods, they cannot unlock the door again.</li> <li>● Patrol: Patrolling users can get their attendance tracked, but they have no unlock permission.</li> <li>● VIP: When VIP unlocks the door, service personnel will get a prompt.</li> <li>● Special: When special people unlock the door, there will be a delay of 5 seconds before the door is closed.</li> </ul>
Use Time	When the user level is <b>Guest</b> , you can set the maximum times that the guest can unlock the door.

Step 3 Tap  to save the configuration.

# 4 Web Operations

The access controller can be configured and operated on the web interface. Through the web interface you can set parameters including network parameters, video parameters, and access controller parameters; and you can also maintain and update the system. For details, see the user manual. Here only describe the login operation.



You need to set a password and an email address before logging in to the web interface for the first time. Password you set is used to log in to the web interface, and the email is used to reset passwords.

**Step 1** Open IE web browser, enter the IP address (192.168.1.108 by default) of the access controller in the address bar, and then press Enter key.



- Make sure that the computer used to log in to the web interface is in the same LAN with the device.
- The 7-inch access controller of model X has dual NICs. The default IP address for 1000M network port is 192.168.1.108, and for 100M network port is 192.168.2.108.

Figure 4-1 Login

**WEB SERVICE**

Username:

Password:

[Forget Password?](#)

**Login**

**Step 2** Enter the username and password.



- The default username of administrator is admin, and the password is the login password after initializing the access controller. Modify the administrator password regularly and keep it properly for security.
- If you forget the administrator login password, you can click **Forget Password?** to reset it. See the user manual.

**Step 3** Click **Login**.

The homepage of the web interface is displayed.



# Appendix 1 Notes of Temperature Monitoring

- Warm up the temperature monitoring unit for more than 20 minutes after power-on to enable the temperature monitoring unit to reach thermal equilibrium.
- Install the temperature monitoring unit in an indoor windless environment, and maintain the indoor ambient temperature at 15°C to 32°C.
- Avoid direct sunlight on the temperature monitoring unit.
- Avoid installing the temperature monitoring unit facing at the light source and glass.
- Keep the temperature monitoring unit away from sources of thermal interference.
- The factors such as sunlight, wind, cold air, and air conditioning cold and warm air will affect the surface temperature of human body, which will cause the temperature deviation between the monitored temperature and the actual temperature.
- Sweating is also a way for the body to automatically cool down and dissipate heat, which will also cause the temperature deviation between the monitored temperature and the actual temperature.
- Maintain the temperature monitoring unit regularly (every 2 weeks). Use a soft dust-free cloth to gently wipe the dust on the surface of the temperature sensor and the distance sensor to keep it clean.

# Appendix 2 Notes of Face Recording/Comparison

## Before Registration

- Glasses, hats, and beards might influence face recognition performance.
- Do not cover your eyebrows when wearing hats.
- Do not change your beard style greatly if you will use the device; otherwise face recognition might fail.
- Keep your face clean.
- Keep the device at least two meters away from light source and at least three meters away from windows or doors; otherwise backlight and direct sunlight might influence face recognition performance of the device.

## During Registration

You can register faces through the access controller or through the platform. For registration through the platform, see the platform user manual.

Make your head center on the photo capture frame. A picture of your face will be captured automatically.

Appendix Figure 2-1 Registration

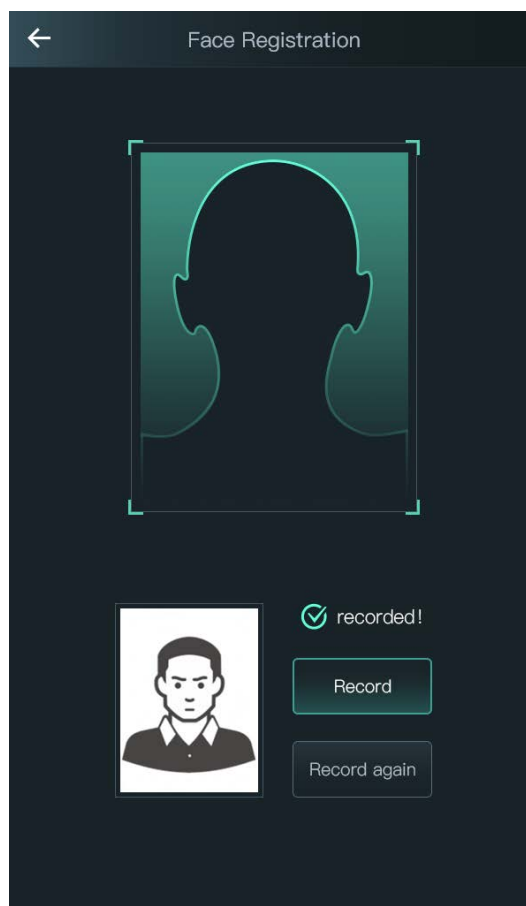



- Do not shake your head or body, otherwise the registration might fail.
- Avoid two faces appear in the capture frame at the same time.

## Face Position

If your face is not at the appropriate position, face recognition effect might be influenced.

Appendix Figure 2-2 Appropriate face position

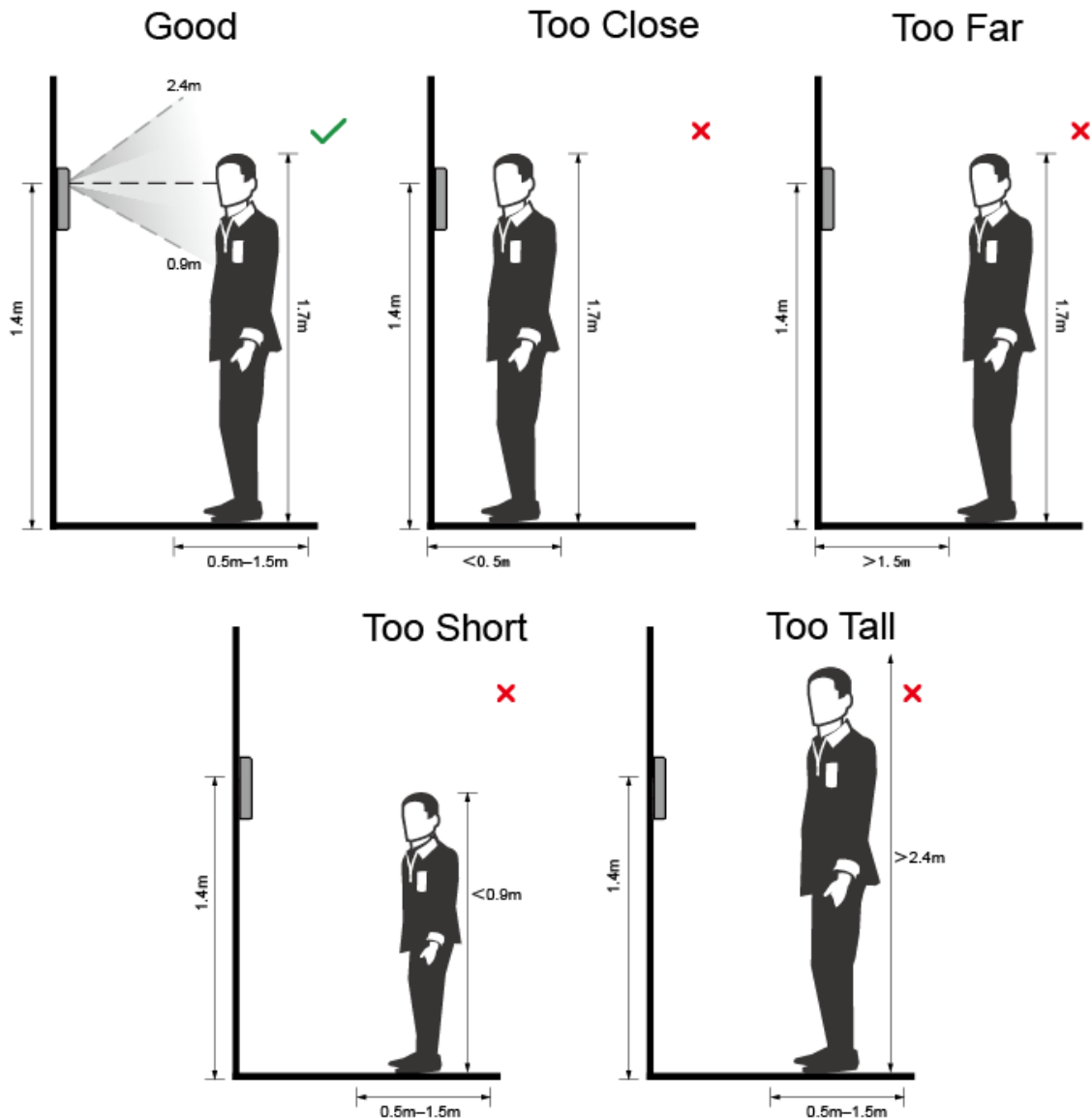

## Requirements of Faces

- Make sure that the face is clean and forehead is not covered by hair.
- Do not wear glasses, hats, heavy beards, or other face ornaments that influence face image recording.
- With eyes open, without facial expressions, and make your face toward the center of camera.
- When recording your face or during face recognition, do not keep your face too close to or too far from the camera.

Appendix Figure 2-3 Head position

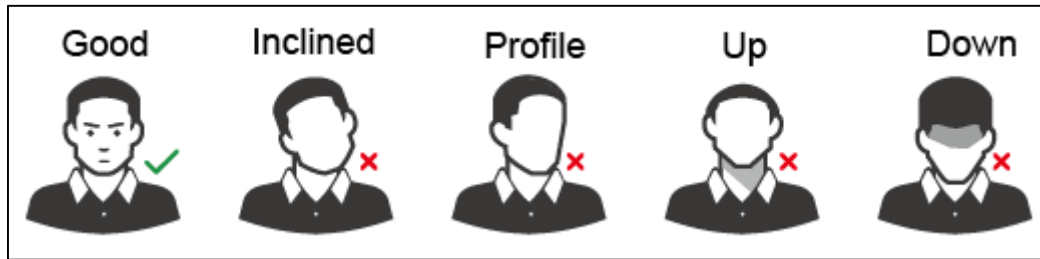

Appendix Figure 2-4 Face distance

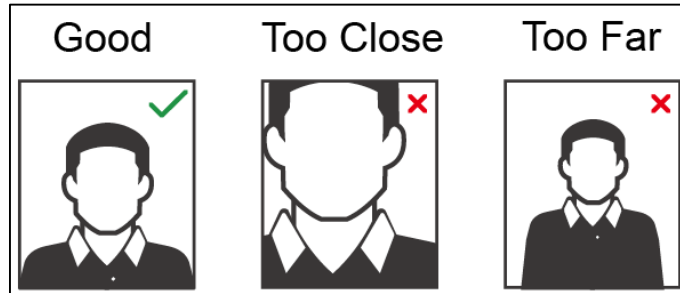

- When importing face images through the management platform, make sure that image resolution is within the range  $150 \times 300$ – $600 \times 1200$ ; image pixels are more than  $500 \times 500$ ; image size is less than 75 KB, and image name and person ID are the same.
- Make sure that face does not take 2/3 of the whole image area, and the aspect ratio does not exceed 1:2.

# Appendix 3 Cybersecurity Recommendations

## **Mandatory actions to be taken for basic device network security:**

### **1. Use Strong Passwords**

Please refer to the following suggestions to set passwords:

- The length should not be less than 8 characters.
- Include at least two types of characters; character types include upper and lower case letters, numbers and symbols.
- Do not contain the account name or the account name in reverse order.
- Do not use continuous characters, such as 123, abc, etc.
- Do not use overlapped characters, such as 111, aaa, etc.

### **2. Update Firmware and Client Software in Time**

- According to the standard procedure in Tech-industry, we recommend to keep your device (such as NVR, DVR, IP camera, etc.) firmware up-to-date to ensure the system is equipped with the latest security patches and fixes. When the device is connected to the public network, it is recommended to enable the "auto-check for updates" function to obtain timely information of firmware updates released by the manufacturer.
- We suggest that you download and use the latest version of client software.

## **"Nice to have" recommendations to improve your device network security:**

### **1. Physical Protection**

We suggest that you perform physical protection to device, especially storage devices. For example, place the device in a special computer room and cabinet, and implement well-done access control permission and key management to prevent unauthorized personnel from carrying out physical contacts such as damaging hardware, unauthorized connection of removable device (such as USB flash disk, serial port), etc.

### **2. Change Passwords Regularly**

We suggest that you change passwords regularly to reduce the risk of being guessed or cracked.

### **3. Set and Update Passwords Reset Information Timely**

The device supports password reset function. Please set up related information for password reset in time, including the end user's mailbox and password protection questions. If the information changes, please modify it in time. When setting password protection questions, it is suggested not to use those that can be easily guessed.

### **4. Enable Account Lock**

The account lock feature is enabled by default, and we recommend you to keep it on to guarantee the account security. If an attacker attempts to log in with the wrong password several times, the corresponding account and the source IP address will be locked.

### **5. Change Default HTTP and Other Service Ports**

We suggest you to change default HTTP and other service ports into any set of numbers between 1024–65535, reducing the risk of outsiders being able to guess which ports you are using.

### **6. Enable HTTPS**

We suggest you to enable HTTPS, so that you visit Web service through a secure communication channel.

### **7. MAC Address Binding**

We recommend you to bind the IP and MAC address of the gateway to the device, thus reducing

the risk of ARP spoofing.

#### **8. Assign Accounts and Privileges Reasonably**

According to business and management requirements, reasonably add users and assign a minimum set of permissions to them.

#### **9. Disable Unnecessary Services and Choose Secure Modes**

If not needed, it is recommended to turn off some services such as SNMP, SMTP, UPnP, etc., to reduce risks.

If necessary, it is highly recommended that you use safe modes, including but not limited to the following services:

- SNMP: Choose SNMP v3, and set up strong encryption passwords and authentication passwords.
- SMTP: Choose TLS to access mailbox server.
- FTP: Choose SFTP, and set up strong passwords.
- AP hotspot: Choose WPA2-PSK encryption mode, and set up strong passwords.

#### **10. Audio and Video Encrypted Transmission**

If your audio and video data contents are very important or sensitive, we recommend that you use encrypted transmission function, to reduce the risk of audio and video data being stolen during transmission.

Reminder: encrypted transmission will cause some loss in transmission efficiency.

#### **11. Secure Auditing**

- Check online users: we suggest that you check online users regularly to see if the device is logged in without authorization.
- Check device log: By viewing the logs, you can know the IP addresses that were used to log in to your devices and their key operations.

#### **12. Network Log**

Due to the limited storage capacity of the device, the stored log is limited. If you need to save the log for a long time, it is recommended that you enable the network log function to ensure that the critical logs are synchronized to the network log server for tracing.

#### **13. Construct a Safe Network Environment**

In order to better ensure the safety of device and reduce potential cyber risks, we recommend:

- Disable the port mapping function of the router to avoid direct access to the intranet devices from external network.
- The network should be partitioned and isolated according to the actual network needs. If there are no communication requirements between two sub networks, it is suggested to use VLAN, network GAP and other technologies to partition the network, so as to achieve the network isolation effect.
- Establish the 802.1x access authentication system to reduce the risk of unauthorized access to private networks.
- Enable IP/MAC address filtering function to limit the range of hosts allowed to access the device.