

## Alcatel-Lucent OmniPCX Office Rich Communication Edition

8068 Premium DeskPhone  
8039 Premium DeskPhone  
8038 Premium DeskPhone  
8029 Premium DeskPhone  
8028 Premium DeskPhone

### User Manual

R100

8AL90894ENACed01-1617



## Introduction

Thank you for choosing an ALE International phone.

This model offers enhanced ergonomical features for more effective communication.

This document describes the services offered by the following sets:

- 8068 Bluetooth® Premium DeskPhone (8068 BT)
- 8068 Premium DeskPhone
- 8039 Premium DeskPhone
- 8038 Premium DeskPhone
- 8029 Premium DeskPhone
- 8028 Premium DeskPhone

The labels and icons displayed on the phone depend on the type of the set.  
Some features are depended on the type of the set.

	8068 BT	8068	8039	8038	8029	8028
IP Phone	✓	✓		✓		✓
Digital Phone			✓		✓	
Color screen	✓	✓				
Monochrome screen			✓	✓	✓	✓
Bluetooth® handset	✓					
Bluetooth® Headset	✓					
Two-port Gigabit Ethernet switch with Power Over Ethernet support	✓	✓		✓		✓
Premium Add-on 10 keys modules	✓	✓	✓	✓	✓	✓
Audio services (hands-free, handset and headset)	✓	✓	✓	✓	✓	✓
Premium Smart display 14 keys module	✓	✓	✓	✓	✓	✓
Adjusting the contrast of the display			✓	✓	✓	✓
Agent set / Supervisor station	✓	✓	✓	✓	✓	✓

The labels and icons presented in this document are not contractually binding and may be modified without prior warning.

<b>1</b>	<b>GETTING TO KNOW YOUR TELEPHONE</b>	<b>7</b>
1.1	8068 BLUETOOTH® / 8068 PREMIUM DESKPHONE	7
1.2	8038/8039 PREMIUM DESKPHONE	7
1.3	8028/8029 PREMIUM DESKPHONE	8
1.4	CONNECTIVITIES	8
1.5	WELCOME SCREENS	9
1.6	NAVIGATION	10
1.7	STATUS ICONS / CALL ICONS	10
1.8	PERMANENT FEATURES KEYS	10
1.9	ALPHABETIC KEYBOARD	11
1.10	ADD-ON MODULE	12
1.11	CALL MANAGEMENT SCREEN	13
1.12	BLUETOOTH® WIRELESS HANDSET	14
<b>2</b>	<b>USING YOUR TELEPHONE</b>	<b>15</b>
2.1	MESSAGING PORTAL	15
2.2	MAKING A CALL	16
2.3	RECEIVING A CALL	17
2.4	USING THE TELEPHONE IN “HANDS FREE“ MODE	17
2.5	ACTIVATING THE LOUDSPEAKER DURING A CONVERSATION (RECEIVER LIFTED) -LOUDSPEAKER.	17
2.6	CALLING A CONTACT USING THE SEARCH BY NAME FEATURE	17
2.7	MAKE CALLS VIA YOUR PROGRAMMED CALL KEYS	18
2.8	FILTERING CALLS USING THE VOICE MAILBOX	18
2.9	REDIALING	19
2.10	CONSULTING THE CALL LOG	19
2.11	REQUESTING AUTOMATIC CALLBACK IF INTERNAL NUMBER IS BUSY	21
2.12	CANCELLING AN AUTOMATIC CALLBACK	21
2.13	RECEIVING INTERCOM CALLS	21
2.14	SENDING DTMF SIGNALS	22
2.15	MUTE, SO THAT YOUR CALLER CANNOT HEAR YOU	22
2.16	SENDING AN INSTANT MESSAGE TO A CONTACT	22
2.17	ANSWERING WITH AN INSTANT MESSAGE	23
2.18	CONSULTING INSTANT MESSAGES	24

<b>3</b>	<b>DURING A CONVERSATION</b>	<b>26</b>
3.1	MAKING A SECOND CALL DURING A CONVERSATION	26
3.2	ANSWERING A SECOND CALL DURING A CONVERSATION	27
3.3	SWITCHING BETWEEN CALLS (BROKER CALL)	27
3.4	TRANSFERRING A CALL	27
3.5	TRANSFER A CALL TO A VOICE MAIL	28
3.6	THREE-WAY CONFERENCE WITH INTERNAL AND/OR EXTERNAL CALLERS (CONFERENCE)	28
3.7	PLACING A CALL ON HOLD (HOLD)	28
3.8	PLACING AN OUTSIDE CALL ON HOLD (PARKING)	29
3.9	INTRUSION INTO AN INTERNAL CONVERSATION	29
3.10	STORE A NUMBER	29
3.11	ADJUST AUDIO VOLUME	29
<b>4</b>	<b>“MEET ME “ CONFERENCE</b>	<b>30</b>
4.1	INITIATE A “MEET ME “ CONFERENCE	30
4.2	JOIN A “MEET ME “ CONFERENCE	30
<b>5</b>	<b>SHARING</b>	<b>31</b>
5.1	RECEIVING SUPERVISED CALL RINGING	31
5.2	ANSWERING THE GENERAL BELL	31
5.3	MANAGER/ASSISTANT FILTERING	31
5.4	CALL PICK-UP	31
5.5	OUTSIDE CALLS TO THE OPERATOR WILL RING ON YOUR TELEPHONE AND YOU CAN ANSWER THE CALL:	32
5.6	HUNTING GROUPS	32
5.7	CALLING AN INTERNAL CALLER ON HIS/HER PAGER	32
5.8	ANSWERING A CALL ON YOUR PAGER	32
5.9	CALLING A CALLER ON HIS/HER LOUDSPEAKER	33
5.10	SEND A VOICE MESSAGE COPY	33
5.11	SENDING A RECORDED MESSAGE TO A NUMBER OR A DISTRIBUTION LIST	33
5.12	BROADCASTING A MESSAGE ON THE LOUDSPEAKERS OF A STATION GROUP	34

---

<b>6</b>	<b>KEEP IN TOUCH</b>	<b>35</b>
<hr/>		
6.1	SELECTING CALLS TO BE FORWARDED	35
6.2	FORWARDING CALLS TO ANOTHER NUMBER (IMMEDIATE FORWARD)	35
6.3	FORWARDING YOUR CALLS TO YOUR VOICE MESSAGE SERVICE	35
6.4	WHEN YOU RETURN, CONSULT RECORDED MESSAGES	35
6.5	ACTIVATEDISABLE THE PERSONAL ASSISTANT	36
6.6	PERSONAL ASSISTANT: REACHING YOU WITH ONE NUMBER ONLY	36
6.7	FORWARDING CALLS TO YOUR PAGER	36
6.8	FORWARDING YOUR CALLS FROM THE RECEIVING TERMINAL (“FOLLOW ME”)	37
6.9	DIVERTING ALL GROUP CALLS	37
6.10	CANCELLING ALL FORWARDS	37
6.11	CANCELLING A SPECIFIC FORWARD	37
6.12	FORWARDING CALLS WHEN YOUR LINE IS BUSY (FORWARD IF BUSY)	37
6.13	DO NOT DISTURB	38
6.14	LEAVING A RECORDED MESSAGE FOR INTERNAL CALLERS	38
6.15	CONSULTING WRITTEN MESSAGES	39
6.16	MESSAGE NOTIFICATION	39
<b>7</b>	<b>MANAGING YOUR CHARGES</b>	<b>40</b>
<hr/>		
7.1	CHARGING YOUR CALLS DIRECTLY TO BUSINESS ACCOUNTS	40
7.2	FINDING OUT THE COST OF AN OUTSIDE CALL MADE FOR AN INTERNAL USER FROM YOUR TERMINAL	40
<b>8</b>	<b>PROGRAMMING YOUR TELEPHONE</b>	<b>41</b>
<hr/>		
8.1	INITIALIZING YOUR VOICE MAILBOX	41
8.2	CUSTOMIZING YOUR VOICE GREETING	41
8.3	MODIFYING YOUR PERSONAL CODE	41
8.4	ADJUSTING THE AUDIO FUNCTIONS	42
8.5	ADJUSTING THE CONTRAST OF THE DISPLAY (8028/8029/8038/8039 PREMIUM DESKPHONE)	43
8.6	SELECTING THE WELCOME PAGE	43
8.7	SELECTING LANGUAGE	43
8.8	PROGRAMMING DIRECT CALL KEYS (PERSO PAGE)	43
8.9	DELETING DIRECT CALL KEYS (PERSO PAGE)	44
8.10	PROGRAMMING DIRECT CALL KEYS (F1 AND F2 KEYS)	44
8.11	DELETING DIRECT CALL KEYS (F1 AND F2 KEYS)	44
8.12	PROGRAMMING DIRECT CALL KEYS (8028/8029 PREMIUM DESKPHONE)	44
8.13	DELETING DIRECT CALL KEYS (8028/8029 PREMIUM DESKPHONE)	45
8.14	PROGRAMMING AN APPOINTMENT REMINDER	45
8.15	IDENTIFY THE TERMINAL YOU ARE ON	45
8.16	LOCK / UNLOCK YOUR TELEPHONE	45
8.17	CONFIGURING THE AUDIO JACK OF YOUR TELEPHONE	46
8.18	ACTIVATING/DEACTIVATING “FORCED HEADSET” MODE	46
8.19	INSTALLING A BLUETOOTH® WIRELESS TECHNOLOGY HANDSET (MATCHING)	46
8.20	USE OF THE BLUETOOTH® HANDSET	47

<b>8.21</b>	<b>INSTALLING A BLUETOOTH® WIRELESS TECHNOLOGY HEADSET (MATCHING)</b>	<b>47</b>
<b>8.22</b>	<b>USING A BLUETOOTH® WIRELESS TECHNOLOGY HEADSET</b>	<b>48</b>
<b>8.23</b>	<b>DELETING AN ACCESSORY (HEADSET, HANDSET, ETC.): BLUETOOTH® WIRELESS TECHNOLOGY</b>	<b>48</b>
<b>8.24</b>	<b>CONTACTING YOUR ADMINISTRATOR</b>	<b>48</b>
<b>9</b>	<b>ACD: AGENT SET / SUPERVISOR STATION</b>	<b>49</b>
<hr/>		
<b>9.1</b>	<b>AGENT SET</b>	<b>49</b>
<b>9.2</b>	<b>OPEN AN AGENT SESSION (LOGIN) – AGENT SET</b>	<b>49</b>
<b>9.3</b>	<b>ACD APPLICATION WELCOME SCREEN – AGENT SET</b>	<b>49</b>
<b>9.4</b>	<b>THE FOUR OPERATING STATUSES OF THE AGENT SET</b>	<b>50</b>
<b>9.5</b>	<b>CHANGING THE OPERATING STATUS OF THE SET – AGENT SET</b>	<b>50</b>
<b>9.6</b>	<b>MODIFYING YOUR PERSONAL CODE – AGENT SET</b>	<b>50</b>
<b>9.7</b>	<b>INTEGRATING ANOTHER GROUP/LEAVING A GROUP – AGENT SET</b>	<b>50</b>
<b>9.8</b>	<b>CLOSE THE AGENT SESSION (LOGOUT) – AGENT SET</b>	<b>50</b>
<b>9.9</b>	<b>SUPERVISOR STATION</b>	<b>51</b>
<b>9.10</b>	<b>SUPERVISING GROUP MAILBOXES – SUPERVISOR STATION</b>	<b>51</b>
<b>10</b>	<b>GUARANTEE AND CLAUSES</b>	<b>52</b>
<hr/>		
<b>10.1</b>	<b>SAFETY INSTRUCTIONS</b>	<b>52</b>
<b>10.2</b>	<b>REGULATORY STATEMENTS</b>	<b>53</b>

# 1 Getting to know your telephone

## 1.1 8068 Bluetooth® / 8068 Premium DeskPhone



## 1.2 8038/8039 Premium DeskPhone



### 1.3 8028/8029 Premium DeskPhone

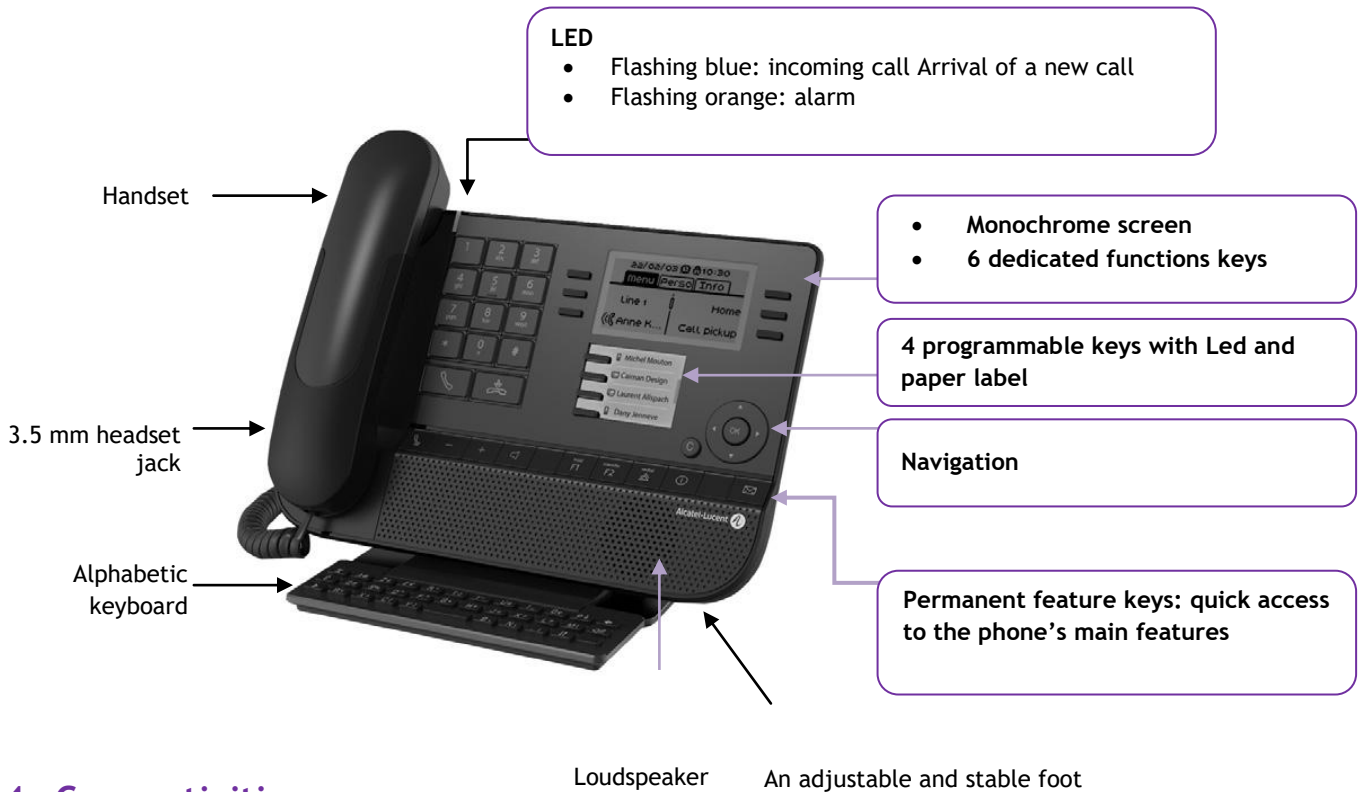





### 1.4 Connectivities

#### Description of the connectors







8029 / 8039

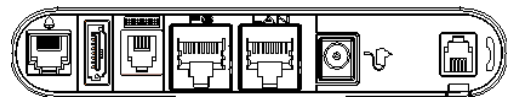

-  Add-on module connector (SATA type).
-  1 RJ 11 connector for external ringer and audio active envelop indicator
-  1 RJ 9 connector for alphanumerical keyboard
-  1 RJ9 connector for a corded handset

8068 / 8038 / 8028



-  1 RJ 11 connector for external ringer and audio active envelop indicator
-  Add-on module connector (SATA type).
-  1 RJ 9 connector for alphanumerical keyboard
-  One 10/100/1000 Gigabit Ethernet connector (PC)
-  One 10/100/1000 Gigabit Ethernet connector (LAN)
-  One DC power jack for an external power adaptor
-  1 RJ9 connector for a corded handset



## Cable path for line connection (8029/8039 Premium DeskPhone)

Make sure you position the cable correctly in the compartment intended for that purpose:

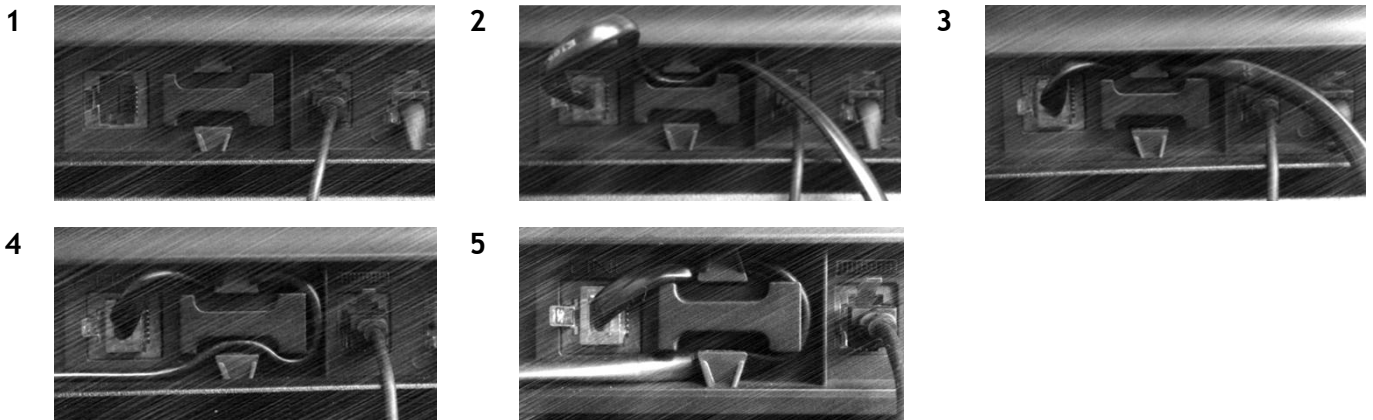



## 1.5 Welcome screens

You can access all of your phone's features from these screens. The default display has three pages that you can access by pressing the page tabs at the top of the screen. The selected page is highlighted.

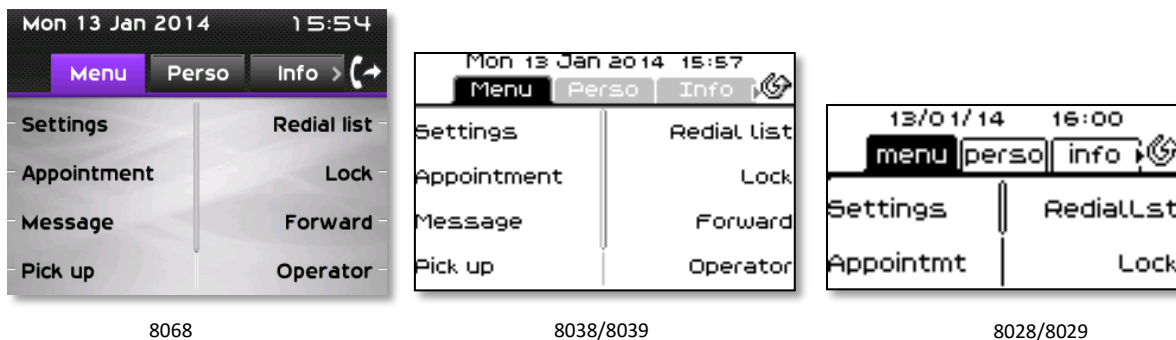
- Menu
- Perso
- Info



- **Menu page:**  
Contains all features and applications accessible by pressing the label of the desired feature or application. From this page, it is possible to adjust the ringer volume, program the time of an appointment, lock the terminal, define the default page displayed, configure voice mail, and access telephone functions such as calling back one of the last numbers or intercepting calls.
- **Perso page:**  
Contains call line keys (allowing supervision of calls) and programmable call keys.
- **Info page:**  
Contains information on the telephone and the status of its functions: name, telephone number, number of messages (including call log events, instant messages and voice messages), activation of transfer function, appointment reminder, etc.
-  /  **Transfer icon:** Pressing the key next to this icon allows you to program or change the transfer function

## 1.6 Navigation



**OK key:** Used to validate your choices and options while programming or configuring

**Left-right navigator:** Used to move from one page to another and display information about current calls (call in progress, calls on hold, incoming call).

**Up-down navigator:** Used to scroll through the content of a page.



**Back/Exit key** Use this key to go back to the previous step. Use this key to go back to the homepage (long press)

## 1.7 Status icons / Call icons

Icons giving information about some specific configurations of the phone or about call status are displayed in the top bar of the screen.



Headset connected



Telephone locked



Appointment programmed



Incoming call icon



Call in progress icon



Call holding icon

## 1.8 Permanent features keys

They are located just above the loudspeaker



Mute and intercom key.

During a call, press this key to stop your contact from hearing you. When idle, press this key to switch the phone to intercom mode. When you receive a call, the phone hooks off automatically and you go straight into handsfree mode. When activated, this is key blue







Turn down the volume Lower the contrast



Turn up the volume Increase the contrast



Pressing this key answers an incoming call in handsfree mode (the key is blue). When a call is in progress, pressing this key switches from handsfree mode to headset or handset mode.

	Programmable keys (F1 and F2 keys). Lit when the function associated with the key is activated. A service or a direct call can be associated to these keys.
	Redial key: to access the 'Redial' feature. Last number redial (short press) Call back on the last 10 number dialed (long press)
	Guide key: Used to obtain information on functions of the “menu“ page and to program key of the “perso“ page
	Messaging key to access the messaging portal (call log, voice messages and instant messages). This key flashes blue when there is a new event such as a new voice message, a new instant message or a new event in the call log.

## 1.9 Alphabetic keyboard





Your set is provided with an alphabetic keyboard depending on you country and language:



- Country variants:
  - AZERTY
  - QWERTZ
  - QWERTY (international)
  - QWERTY (nordic)

Use the keyboard to enter names while configuring the phone. Directly access the dial by name feature by entering the name of your caller on the keyboard.

Below is a list of the function keys that allow you to access all the symbols

	Cursor moving keys (left, right, up and down). Allows you to navigate edit boxes. Press the Alt key to access the left and up directions
	Caps lock: to write text in capital letters.
	Alt key. To access specific and punctuation characters.
	Enter key: to validate edited text.
	Backspace key: to delete one character in an edit box.

## 1.10 Add-on module

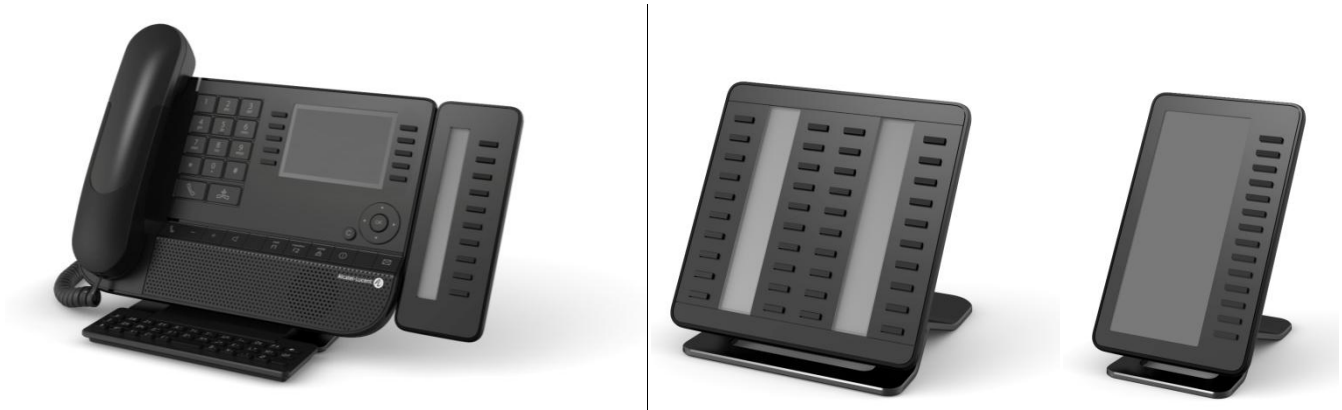

Flashing blue: incoming call

### Installation

#### Premium Add-on 10 keys modules



1. Remove the protection of the dedicated compartment behind the set
2. Insert the add-on correctly in the compartment
3. Plug the provided cord into the dedicated socket behind your set
4. Fix the add-on with the provided screw

#### Premium Add-on 40 keys / Premium Smart Display 14 keys:

1. Plug the provided cord into the dedicated socket behind your phone
2. If desired, fix the foots (set and add-on) with the provided clip

## 1.11 Call management screen

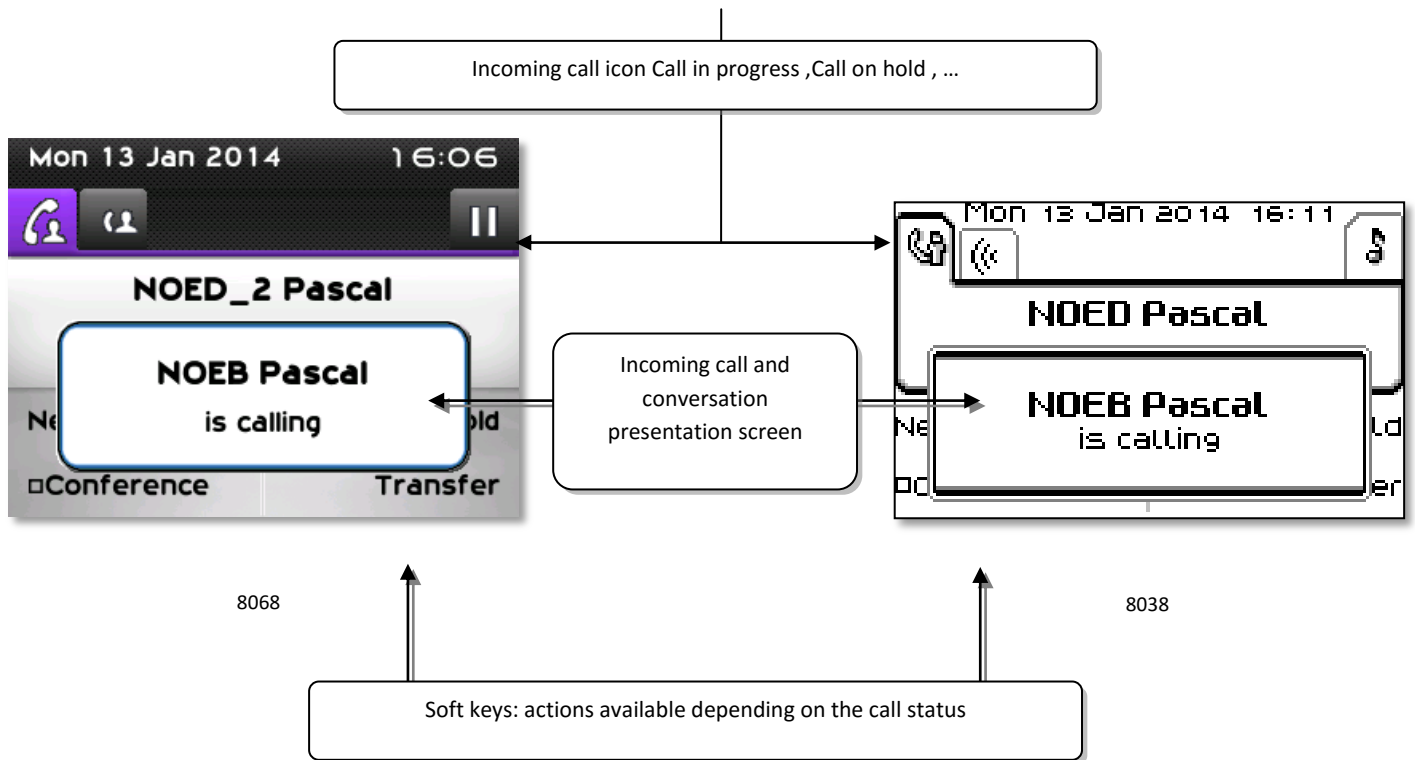

Each tab corresponds to a call, the status of which is symbolized by its icon (in progress, held, arrival of new call). When a call is in progress, use the left-right navigator to look at held or incoming calls.



All features are accessible while the call is displayed on the screen. Use the Up and Down arrows to move up or down a page. These functions (transfer, conference, etc.) are directly related to the status of the call consulted. For example, the transfer function will not be available between a call in progress or a held call and an incoming call.



Used to switch from a telephone screen to an application screen. For example, it can be used while a call is in progress to search a number, program an appointment reminder, etc

Calls can also be managed from the Perso page. While the call is in progress, press the Back/Exit key and display the Perso page. Calls in progress or waiting calls are displayed on the different line keys. It is then possible to converse with the caller of your choice by pressing the key associated to the caller.

## 1.12 Bluetooth® Wireless handset

The Bluetooth® Wireless handset is only available with the 8068 Bluetooth® Premium DeskPhone.



If the Bluetooth® handset is on its base, you do not need to press the Off-hook/On-hook key to take or terminate the call. Just off-hook/on-hook the Bluetooth® handset.

### LED

- Off: operating normally
- Blinking green: in communication
- Green steady: handset charging
- Orange flashing: battery charge low or handset outside coverage zone
- Orange steady: malfunction

### Installing or replacing the Bluetooth® handset battery

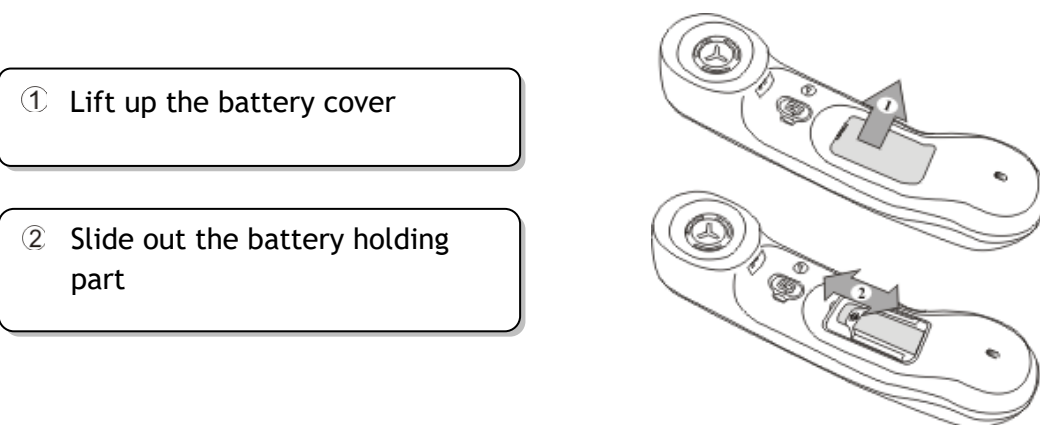

The battery recharges when the Bluetooth® handset is on its base.

## 2 Using your telephone

### 2.1 Messaging portal

The messaging portal allows you to access and manage features such as the call log, instant messaging and voice messages. When there is a new event (new log, new instant message or new voice message) the message key blinks blue.

#### Accessing the messaging portal





-  Press the message key to access the messaging portal.

#### Accessing the features of the messaging portal

To access the available features (call log, instant messages, voice messages, sending an instant message), press the associated softkey.





#### Acknowledging

When you consult a new event (call log, instant message or voice message), the event is automatically acknowledged. However, you can choose to acknowledge all events without consulting them.

-  Access the messaging portal
-  Press the associated softkey.
-  Press the softkey associated with the type of event you want to acknowledge. If you press the key associated with the “all” option, all new events are acknowledged. You can also acknowledge all events if you press the softkey associated with the check icon in the top right corner of the screen.
-  Press to confirm.



#### Deleting

When consulting an event (call log, instant message or voice message), you can delete the event once you have consulted it. However, you can choose to delete all events in one go.

-  Access the messaging portal
-  Press the associated softkey.
-  Press the softkey associated with the type of event you want to delete.
-  Press to confirm.







## Configure access to the messaging portal

The system default setting requires you to enter a password to access the messaging portal features. You can change the setting so that you don't have to enter a password each time you want to access the messaging portal features.

-  Access the messaging portal
- *Configure*
- *Authentication*
- Enter your personal password
- Set authentication to on or off.  
On: password is always required.  
Off: password is never required.
-  Press to confirm.

## 2.2 Making a call

Use one of the following:

- Dial directly the number for your call
- Lift the receiver  Enter the destination number
-  Press the on-hook/off-hook key of the Bluetooth® device (Bluetooth® Wireless handset)   
Dial the destination number
-  Hands free  Dial the destination number
- Programmed line key
- Dial by name (enter the first letters of the contact's name on the alphapad and press OK to start the search)
-  From call log after accessing the messaging portal.
-  Redial last number

To make an external call, dial the outside line access code before dialing your contact number

The duration of your external call may be limited in time by the administrator. In this case, a beep sounds and/or a message will be displayed on the screen 20 seconds before the end of the communication

### If the internal or outside number does not reply:



Use one of the following:

- *Interphony*: Broadcast a message on the loudspeaker of the free terminal
- *Callback*: Request callback to a busy terminal
- *Text*: Send a written message





## 2.3 Receiving a call

Use one of the following:

- Lift the receiver
-  Press the on-hook/off-hook key of the Bluetooth® device (Bluetooth® Wireless handset)
-  Hands free
-  Press the key next to the incoming call icon

## 2.4 Using the telephone in “Hands free“ mode

Terminal idle:









-  Press and release  You are in hands free mode
-  Terminate your call

Call in progress:

- During a conversation
-  Press and release  You are in hands free mode

During a conversation, you can lift the receiver without terminating the call.

## 2.5 Activating the loudspeaker during a conversation (receiver lifted) - Loudspeaker.

- During a conversation
-  Activate loudspeaker   The key lights up
-   Adjust volume (9 levels)
-  Deactivate loudspeaker   The key is no longer lit

Press and release the loudspeaker key to switch to hands free mode (light steady).

## 2.6 Calling a contact using the search by name feature

You can call a contact using the search by name feature. This feature enables you to call a contact directly on their company phone or call them on another phone using their contact card.

- Enter the first letters of the name  
When entering the name you can extend the search by adding the first letters of the first name after entering the “#” symbol or pressing: *1stname*.
-  Start the search.
- A list of matching names is displayed on the screen. Each contact is displayed with their name and company phone number.

### Call your contact using the company phone number

- Press the key associated with the company phone number

### Call your contact using another phone number (via contact card):

- Press the softkey associated with the contact name:

The contact card opens and displays information about the contact: last name and first name, several phone numbers (Office, mobile, home), email address, instant message address and the company name.

- Scroll through the screen with the up and down navigation keys and position the cursor on the contact phone number you wish to call.
-  Start the call

From the contact card you can also send an instant message



Use the Guide key to display information that is truncated.

You can change the search by name function to predictive search mode by setting the unified directory to “Off” in the settings menu (available once a search by name is started). Please be aware that predictive searching means that you won’t access the contact card and therefore can only call the contact on their company phone and cannot send instant messages.

## 2.7 Make calls via your programmed call keys

- Access the “Perso” page
- Find the caller you want to call from the programmed call keys
- Call the chosen caller

## 2.8 Filtering calls using the voice mailbox

This service lets you filter incoming calls to your voice mailbox. When your caller leaves his message you can choose to communicate with him



### Activating call screening

- Voice mail filtering programmed key
- Enter your personal password
- Same key to stop listening and deactivate the screening

### When you receive a call

You hear the message left by your caller

Use one of the following:



-  Hands free to take the call
- Lift the receiver
-  To stop listening only

## 2.9 Redialing

### Redialing the last number dialed (redial)

-  (short press) >> Last number redial

### Call back on the last 10 number dialed

-  (long press)
- Select the number to redial from the last 50 dialed numbers
-  or  Start the call

You can also access this feature through the menu:

- Reach the “Menu“ page
- *Redial list*
- Select the number to redial from the last 50 dialed numbers

## 2.10 Consulting the call log

At any time, you can consult all answered and unanswered incoming and outgoing calls. To do this, go to the call log feature on the messaging portal.

-  Access the messaging portal
- Press the softkey associated with the call log feature.

You can choose between consulting missed calls only (“Missed” tab) and consulting all call logs including unanswered/answered, incoming and/or outgoing calls (“All” tab).

### Consulting missed calls



- Using the left/right navigator key, select the “Missed” tab. Unacknowledged calls are in bold characters.
- Using the up and down navigation key, select the log to consult.
-  Display the log details.

Information such as the name, phone number, date and time are displayed on the screen.

You can choose to call the contact, send an instant message to the contact, save the contact in the personal phonebook, or clear the log.



### Acknowledge all missed calls:

Once a new log is consulted, it is automatically acknowledged. However, you can acknowledge all new missed calls without consulting them.

-  Press the associated softkey.
-  Press the associated softkey.

All missed calls are acknowledged.

### Delete all missed calls:

-  Press the associated softkey.
-  Press the associated softkey.
-  Press to confirm.



All missed calls are deleted.

### Consulting all calls





- Using the left/right navigator key, select the “All” tab.

All calls are displayed with an icon giving information on the type of call.

For the 8068 Premium DeskPhone:

	Answered outgoing calls		Answered incoming calls
	Unanswered outgoing calls		Unanswered incoming calls

For the 8039/8038/8029/8028 Premium DeskPhone:



	Answered outgoing calls		Answered incoming calls
	Unanswered outgoing calls		Unanswered incoming calls

- Using the up and down navigation key, select the log to consult.
-  Display the log details.



Information such as the name, phone number, date and time are displayed on the screen.

You can choose to call the contact, send an instant message to the contact, save the contact in the personal phonebook, or clear the log.

**Acknowledge all missed calls:**

-  Press the associated softkey.
-  Press the associated softkey.  
All missed calls are acknowledged.

**Delete all call logs:**

-  Press the associated softkey.
-  Press the associated softkey.
- Press to confirm.  
All call logs are deleted.

## 2.11 Requesting automatic callback if internal number is busy

- Internal number busy
- *Call back* >> Callback request acknowledged
- 

Automatic callback is not available if the set of your caller is free or if you are put on hold when the set is busy

## 2.12 Cancelling an automatic callback

- When your phone rings
- *Call back* >> *Cancellation of callback request acknowledged*

Canceling the callback request is only possible when the caller you tried to reach released the line.

## 2.13 Receiving intercom calls

You can answer a call without lifting the receiver. When you receive a call, you are automatically connected in hands-free mode. The identity of the caller is displayed on the screen.

**To activate -Terminal idle:**

-  >> Corresponding LED lights up

When your caller hangs up, interphony mode remains active.

**To deactivate -Terminal idle:**

-  >> The corresponding LED goes out

## 2.14 Sending DTMF signals

During a conversation you sometimes have to send DTMF signals, such as with a voice server, an automated attendant or a remotely consulted answering machine.



- During a conversation
- *Send DTMF*
- Enter DTMF code

The function is automatically cancelled when you hang up.

## 2.15 Mute, so that your caller cannot hear you

You can hear your caller but he/she cannot hear you:

### From the set

- During a conversation
-  Disable microphone >> The key lights up
-  Resume the conversation >> The key is no longer lit





### From the Bluetooth® receiver (Bluetooth® wireless handset)

-  Press the handset volume/mute key (long press)



## 2.16 Sending an instant message to a contact

You can send an instant message to a contact by entering either their phone number or their name

### Sending an instant message using the search by name feature



-  Access the messaging portal
- *Send IM*
- Enter the first letters of the name  
When entering the name you can extend the search by adding the first letters of the first name after entering the “#” symbol or pressing: *1stname*.
-  Start the search.
- A list of matching names is displayed on the screen. Each contact is displayed with their name and company phone number.
- Press the softkey associated with the contact name:  
The contact card opens and displays information about the contact: last name and first name, several phone numbers (Office, mobile, home), email address, instant message address and the company name.
- Scroll through the screen with the up and down navigation keys and position the cursor on the instant message address.
-  Access instant message writing mode.
- Write the instant message to send.
-  Send the instant message.

## Sending an instant message using the phone number

-  Access the messaging portal
- *Send IM*
- Enter your contact's phone number
-  Access instant message writing mode.
- Write the instant message to send.
-  Send the instant message.

## Status of the instant messages





Once the instant message has been sent, the message is stored in the “Sent” tab of the instant message feature in the messaging portal. The status of the message is as follows:

	Instant message has been sent but not yet delivered
	Instant message has been delivered
	Instant message has been read



## 2.17 Answering with an instant message

You can send instant messages to your contacts when you have received an instant message or a voicemail or you can send instant messages when consulting the call log.



### Answering an Instant message

-  Access the messaging portal
- Select the instant message feature by pressing the associated softkey
- Using the left and right navigation keys, access one of the following tabs: new messages, received messages, sent messages or all messages.
- Using the up and down navigation keys, position the cursor on the instant message you want to answer.
-  Select the instant message.
-  Answer the instant message by pressing the associated softkey.
- Write the instant message to send.
-  Send the instant message.

## Answering a voice message





-  Access the messaging portal
- Select the voicemail feature by pressing the associated softkey.
- Using the left and right navigation keys, access one of the following tabs: new voice messages or all voice messages.
- Using the up and down navigation keys, position the cursor on the voice message you want to answer with an instant message.
- When details of the voice message are displayed on the screen, press the softkey associated with the instant message.
- Write the instant message to send.
-  Send the instant message.

## Answering from the call log

-  Access the messaging portal
- Press the softkey associated with the call log feature.
- Using the left and right navigation keys, access one of the following tabs: missed calls or all calls.
- Using the up and down navigation keys, position the cursor on the call log you want to consult.
-  Select the call log.
- When details of the call log are displayed on the screen, press the softkey associated with the instant message feature.
- Write the instant message to send.
-  Send the instant message.

## 2.18 Consulting instant messages

You are notified of a new event when the message key is flashing.

-  Access the messaging portal
- Select the instant message feature by pressing the associated softkey
- Using the left and right navigation keys, access one of the following tabs: new messages, received messages, sent messages or all messages.
- Using the up and down navigation keys, position the cursor on the instant message you want to read.
-  Select the instant message.
- Once the instant message is read, you can:
  -  Answer the instant message by pressing the associated softkey.
  -  Delete the instant message by pressing the associated key.
  -  Press OK to call the sender of the instant message.



When a message is read, the status of the message changes from unread to read on both sides (on the recipient side and the sender side).

You can use the filter key to consult messages sent by or to a particular contact. For example, when you are on a message sent by a contact, pressing the filter key shows only messages sent to or by that contact.





## Acknowledge new instant messages

Once a new instant message is read, it is automatically acknowledged. However, you can acknowledge all new instant messages without reading them.

-  Press the associated softkey.
-  Press the associated softkey.  
All new instant messages are acknowledged

## Delete instant messages

When consulting the instant messages, you can choose to delete the messages stored in the following tabs: new, sent, received or all messages.



-  Press the associated softkey.
-  Press the associated softkey.
-  Confirm deletion

## 3 During a conversation

### 3.1 Making a second call during a conversation

During a conversation

Use one of the following:

- Dial directly the number for your call.
- Name of second caller.
- *New call* > Number of second caller
-  (long press) or  / Menu page: / *Redial list* / Select the No. in the last ten issued
-  / Perso page / Programmed line key

> The first call is on hold



#### Cancel your second call

Use one of the following:

- On hook the handset
-  Hang up key (If in handsfree mode)

#### Recover the call on hold:

Use one of the following:

-  Key associated with the “incoming call“ icon
-  Hands free to take the call
- Lift the receiver
-  Start call key

You are in conversation with your first caller again

If you make an error, hang up: your telephone will ring and you will recover your first call.

## 3.2 Answering a second call during a conversation

- During a conversation, another person is trying to call you. The name or number of the caller is displayed for a few seconds
- Use one of the following methods to answer the displayed call
  - Line key for which icon is flashing 
  - *Answer*
- The first call is on hold



### Cancel your second call

Use one of the following:

- On hook the handset
-  Hang up key (If in handsfree mode)

### Recover the call on hold:

Use one of the following:

-  Key associated with the “incoming call“ icon
-  Hands free to take the call
- Lift the receiver
-  Start call key

You are in conversation with your first caller again

If you make an error, hang up: your telephone will ring and you will recover your first call.

## 3.3 Switching between calls (Broker call)

During a conversation, a second call is on hold.

To accept the second call:

- Select the contact on hold **>>** Your first call is placed on hold

## 3.4 Transferring a call

To transfer your call to another number:

- During a conversation
- Calling a second person during a conversation **>>** The first call is on hold
- You can transfer the call immediately or wait for your contact to answer before transferring the call
- *Transfer*

Transfer between two outside calls is not generally possible (depends on country concerned and system configuration).

### 3.5 Transfer a call to a voice mail

During the call, you want to transfer your caller to the voice mailbox of another caller

- *TransferVMU*
- Number of second caller

### 3.6 Three-way conference with internal and/or external callers (conference)

- During a conversation, a second call is on hold
- *Conference* >> You are in conference mode

**Cancel conference and return to first caller (If conference is active)**

- *Conference*

**Hang up on all caller (If conference is active)**

Use one of the following:

-  Hang up
- On hook the handset

**After the conference, to leave your two callers talking together:**

- *Conference*
- *Transfer*

### 3.7 Placing a call on hold (hold)

During a conversation, you wish to place the call on hold and recover it later, on the same telephone.

- During a conversation
- *Hold* >> Your call is placed on hold 

Recover the call on hold:

- Select the call on hold

### 3.8 Placing an outside call on hold (parking)

You can place an outside call on hold and recover the call on another telephone:

- During a conversation
- *Park call*

**To recover the parked call:**

- Reach the “Menu“ page
- *Pickup > Unparkcall*

If the parked call is not recovered within a preset time (default value 1 min 30), it is transferred to the operator.

### 3.9 Intrusion into an internal conversation

Your caller’s line is busy. If the number is not “protected“ and if authorised, you can intrude into the call:

- *∗Intrusion*
- Same key to exit (*∗Intrusion*)

**Protection against intrusion:**

- Press programmed key
- Enter caller’s number

Protection is cancelled when you hang up.

### 3.10 Store a number

During a call, to save the number onto a call key:

During a conversation

- *Savetorep*
- Press a call key on the Perso page
- Enter the name of your caller
- Apply

### 3.11 Adjust audio volume

During a call, to adjust the volume level of the loudspeaker or receiver:

- During a conversation
-   Adjust audio volume

## 4 “Meet me “ conference

The “Meet me “ function is used to set up a conference with a maximum of 6 persons: the “master “ of the conference (who has the rights for initiating the conference) and the participants (maximum of 5) who meet for the conference.

### 4.1 Initiate a “Meet me “ conference

In order for the participants to join the conference, you must first decide on a meeting time for the conference and send them the access code.

When the system prompts you to enter a code or password, you are allowed 3 attempts before the system rejects your request.

- Lift the receiver
- Enter the “Meet me “ conference activation code
- Enter your telephone number (internal)
- Enter your personal password
- Enter the conference access code

The conference is set-up.

**Activation code:** This code is defined by the administrator during system configuration.

**Call number for activating the “Meet me “ conference:** this call number is used by the conference master when he wishes to initiate a conference from an external set. This number must have been defined previously by the system administrator.

When the conference master on-hooks, all the communications will be cut-off.

### 4.2 Join a “Meet me “ conference

Once set-up by the conference master, the participants can join the “Meet me “ conference (5 participants maximum).

- Lift the receiver
- Enter the joining code for the “Meet me “ conference
- Enter the conference access code

You are in conference mode

**Joining code** This code is defined by the administrator during system configuration.

**Call number for joining the “Meet me “ conference:** this call number allows the participants to join a conference from an external set.

An audible beep sounds when a participant joins the conference. 2 audible beeps sound when a participant leaves the conference.

You cannot join a conference if there are already the maximum number of participants.

If the conference has not yet been set up by the conference master you are put on hold until the conference is initiated (5 minutes maximum).

If you cannot directly reach the conference, you have to call first an internal user or an automatic operator. This one dials the call number for joining the “Meet-me “ conference and then transfers your call (10 seconds).

# 5 Sharing

## 5.1 Receiving supervised call ringing

To receive the special ringing for calls to another number:

- Supervised call ringing programmed key
- Same key to cancel

## 5.2 Answering the general bell

When the operator is absent, outside calls to the operator are indicated by a general bell. To answer:

- Reach the “Menu“ page
- *Pickup* > *Generalbell*

## 5.3 Manager/Assistant filtering

System configuration allows “Manager/Assistant“ groups to be formed, so that the manager’s calls can be directed to one or more assistants.

**From the manager or assistant telephone:**

- Filter programmed key >> Incoming calls are filtered by a chosen person (assistant, etc.)
- Same key to cancel

Filtering is indicated on the manager’s telephone by the icon corresponding to the “screening“ programmed key.

## 5.4 Call pick-up

You hear a telephone ringing in an office where no-one can answer. If authorised, you can answer the call on your own telephone.

**If the telephone ringing is in your own pick-up group:**

- Group call pick-up programmed key

**If the telephone ringing is not in your pick-up group:**

- Reach the “Menu“ page
- *Pickup* > *Set*
- Enter the number of the ringing telephone

The system can be configured to prevent call pick-up on certain telephones.

## 5.5 Outside calls to the operator will ring on your telephone and you can answer the call:

- Operator help programmed key
- Your telephone will ring at the same time as the switchboard
- Same key to cancel

### **Calls to the switchboard:**

Calls to the switchboard will ring on your telephone

- Lift the receiver
- 
- Operator help programmed key

## 5.6 Hunting groups

### **Hunting group call:**

Certain numbers can form a hunting group and can be called by dialling the group number.

- Lift the receiver
- No. of group to be called

### **Temporary exit from your hunting group: /Return into your group:**

- Leave group programmed key
- Enter your group number

Belonging to a group does not affect the management of direct calls. A specific telephone within a group can always be called by using its own number.

## 5.7 Calling an internal caller on his/her pager

The number called does not answer and you know that the person called has a pager:

- Paging programmed key
- Paging in progress is displayed

Your caller can answer from any telephone in the system.

## 5.8 Answering a call on your pager

A call on your pager can be answered from any telephone within the system.

Your pager beeps

- Answer paging programmed key
- Enter your group number





## 5.9 Calling a caller on his/her loudspeaker

Your internal caller does not answer. If authorised, you can remotely activate your caller's phone:

- Your caller does not reply
- *Interphony*

You are connected to the loudspeaker on your caller's phone (if he/she has the hands free function)





## 5.10 Send a voice message copy

-  Access the messaging portal
- Press the softkey associated with the voice message feature.
- Using the left and right navigation keys, select the tab to consult (new or all messages).
- Using the up and down navigation keys, position the cursor on the voice message you want to send.
-  Select the message to send.
- *Sendcopy*
- Enter the destination number
- 
- *Sendmessage*

When sending a copy of the message, you can also record a comment to join to the copy

- *Record*
- Start recording the comment
- *Stop*
- 

## 5.11 Sending a recorded message to a number or a distribution list

-  Access the messaging portal
- Press the softkey associated with the voice message feature.
-  Press the associated softkey.
- Enter the number of the recipient or select a destination list.
- or
- Enter the name of the recipient using the alphapad.
- 
- *Record*
- Start recording the comment
- *Stop*
-  Send the message.

## 5.12 Broadcasting a message on the loudspeakers of a station group

A message not requiring an answer can be broadcasted on the loudspeakers within your broadcast group:

- Off hook
- Number of broadcast group >> Speak, you have 20 seconds
-  or Hang up

The message will only be broadcast on terminals not in use and which have a loudspeaker.

# 6 Keep in touch



## 6.1 Selecting calls to be forwarded

When a forward is applied, you can select the types of call to be forwarded: outside, internal, all.

- 
- *Ext/Int* >> Select the type of Out/Int call >> type of call forwarded is displayed
- *Allcalls* >> forward internal and outside calls
- *External* >> Forward outside calls
- *Internal* >> Forward internal calls

## 6.2 Forwarding calls to another number (immediate forward)

The number can be your home, mobile or car phone, voice mailbox or an internal extension (operator, etc.).

- 
- *Immediate*
- Number to be called >> Forward is acknowledged
- 

You can also select the destination number of the forward through the redial feature or the individual repertory.



You can make calls, but only the destination number can call you.

## 6.3 Forwarding your calls to your voice message service

- 
- *Immediate»VM* >> Forward is acknowledged
- 

## 6.4 When you return, consult recorded messages

You are notified of a new event when the message key is flashing.



-  Access the messaging portal
- Press the softkey associated with the voice message feature.
- Using the left and right navigation keys select the new voice messages tab.
- Using the up and down navigation keys position the cursor on the message you want to listen to.
-  Select the message to listen to.

Display name of sender, with date, time and ranking of message

- *Play* » Listen to message
- *Clear* » Erase message
- *Call* » Call back sender of message
- *Sendcopy* » Copy message
- *Send IM* » Send an instant message

### Acknowledge all new voice messages

Once you start listening to a voice message, the message is automatically acknowledged. However, you can acknowledge voice messages without listening to them.

-  Press the associated softkey.
-  Press the associated softkey.
- 

### 6.5 Activatedisable the personal assistant

- Reach the “Menu“ page
- *Settings* » *Assistant*
- *On* or *Off* » Activate or deactivate the assistant
- 

### 6.6 Personal assistant: reaching you with one number only

- Reach the “Menu“ page
- *Settings* » *Assistant* » *Menu*
- You can then choose where to route the calls:
  - *InternalNr* » Dial number of a colleague or your assistant
  - *ExternalNr* » Dial an outside line number
  - *MobileNr* » Dial number of your mobile or DECT
  - *Operator* » Activatedeactivate transfer to operator
- 

### 6.7 Forwarding calls to your pager

Callers will thus be able to contact you while you are moving around the company:

- 
- *Topaging* » Forward is acknowledged

## 6.8 Forwarding your calls from the receiving terminal (“Follow me“)

You wish to receive your calls in your present location:  
Use the “Follow me“ function.

- 
- *Followme*
- Dial your extension number >> Forward is acknowledged

If you have a key programmed with this feature, you can access the feature directly

- Press programmed key
- Dial your extension number >> Forward is acknowledged

## 6.9 Diverting all group calls

You can forward all your group calls to another internal number:

- Group calls forwarding programmed key
- Enter the destination number
- Forward is acknowledged

## 6.10 Cancelling all forwards

- 
- *Cancel fwd.*

To cancel all forwards, you can programme another type of forward too

## 6.11 Cancelling a specific forward

- Programmed key corresponding to type of forward (group or selective)

## 6.12 Forwarding calls when your line is busy (forward if busy)

Callers can be forwarded to another telephone if you are already on the line

- 
- *Onbusy*
- Enter the destination number >> Forward is acknowledged

## 6.13 Do not disturb

You can make your terminal temporarily unavailable for all calls.

- 
- *DoNotDisturb* >> Forward is acknowledged

Callers wishing to contact you will see the “Do Not Disturb” message displayed on their sets when they try to call.

## 6.14 Leaving a recorded message for internal callers

You can leave a message on your terminal which will be displayed on the screen of the terminal calling you.

- 
- *Textanswer*
- Choose the type of message

### Sending predefined message

- *FixedMsg*
- Select the message to be sent
- 

Enter the number of the ringing telephone *Language*

Notice that you can select the message to send by its number by selecting the option: *Gotomessage*

The 27 standard messages are shown below:



1	Call me back	15	Meeting on ___ (*)
2	Call me back tomorrow	16	Meeting on ___ at _:_ (*)
3	Call me back at _:_ (*)	17	Out for a while
4	Call back _____ (*)	18	Absent for the rest of the day
5	Call the attendant	19	Absent, back at _:_ (*)
6	Call the assistant	20	Absent, back on ___ at _:_ (*)
7	I will call back at _:_ (*)	21	On vacation, back on ___ (*)
8	Use paging	22	External meeting
9	Please fetch your fax	23	External meeting, back on ___ (*)
10	Please fetch your mail	24	I am in room nr __ (*)
11	Please cancel your forwarding	25	In a meeting - do not disturb
12	Visitors are waiting	26	At lunch
13	You are expected at reception	27	Indisposed
14	Meeting at _:_ (*)	(*)	Messages to be completed using numeric keypad

## Sending a new message

- *NewMsg*
- Write your message
- 

## 6.15 Consulting written messages

The light indicates that messages have been received.

-  **>>** Number of messages received
- *ReadTxtMsg* **>>** Displays the sender's message on the screen
- *Readmore* **>>** Displays the rest of the message and the date and time it was left
- Activating/Deactivating "Forced headset" mode
  - Use the left-right navigator to see previous and next messages
  - *Clear* **>>** Erase message
  - *Call* **>>** Call back sender of message
  - *SendTxtMsg* **>>** *Sending a written message to an internal caller.*
  - *Savetorep* **>>** Save the sender's number in your directory
  -  **>>** Terminate consultation

## 6.16 Message notification

A message is left in your mailbox but you are not at your desk. You can configure your telephone so that you receive notification of the message on another telephone

- Reach the "Menu" page
- *Settings* **>** *Notification*
- Press consecutively to activate/deactivate
- *ON/OFF*
- *Choice* **>>** Press consecutively to activate/deactivate
- 

### Change the time slot

The time slot during which notification is activated can be changed

- *Schedule*
- Change times
- 

# 7 Managing your charges

---

## 7.1 Charging your calls directly to business accounts

You can charge the cost of your outside calls to business account numbers.

- Reach the “Menu“ page
- *Settings* › *My services* › *Consultation* › *Additional services* › *Business account code*
- Number of business account
- Number required

## 7.2 Finding out the cost of an outside call made for an internal user from your terminal

- Reach the “Menu“ page
- *Settings* › *My services* › *Consultation* › *Consultation & callbacks* › *Charging informations*



# 8 Programming your telephone

## 8.1 Initializing your voice mailbox

- Light flashes
- 
- Enter your personal code then record your name according to voice guide instructions

Your personal code is used to access your voice mailbox and to lock your telephone.

Your password has 6 digits. A weak personal code with 6 identical digits (000000, 111111, etc.) or a simple sequence of 6 digits (012345, 123456, etc.) will be rejected by the system. After a system upgrade, the password may still have only 4 digits. For security reasons, we recommend you use a password with 6 digits. Contact your installer for more information.

## 8.2 Customizing your voice greeting

You can replace the greeting message by a personal message

- Reach the “Menu“ page
- [Settings](#) › [Mailbox](#)
- You can listen to the greeting, customize the greeting and set the default greeting ([Listen](#) , [Recordname](#) , [Default](#))
- You can replace the greeting message by a personal message ([Persmessage](#))
- You can pause, resume or stop the recording at any time

## 8.3 Modifying your personal code

- Reach the “Menu“ page
- [Settings](#) › [Options](#) › [Password](#)
- Old code (6 digits)
- New code (6 digits)
- 



As long as your voice mailbox has not been initialized, personal code is 1515.

Your password has 6 digits. A weak personal code with 6 identical digits (000000, 111111, etc.) or a simple sequence of 6 digits (012345, 123456, etc.) will be rejected by the system. After a system upgrade, the password may still have only 4 digits. For security reasons, we recommend you use a password with 6 digits. Contact your installer for more information.





## 8.4 Adjusting the audio functions

- Reach the “Menu“ page
- *Settings* › *Phone* › *Ringing*



### Choose the tune

- *Int Melody /Ext Melody*  
The tune must be chosen for external and internal calls
- Select the melody of your choice (16 tunes)
- 
-  End



### Adjusting the ringer volume

- *Volume*
-   Select the volume you want: (10 levels)
- 
-  End



### Activate/deactivate silent mode

- *Silent*
- *ON/OFF* ›› activate/deactivate
- 
-  End



### Activate/deactivate meeting mode (progressive ringing)

- *Progressive*
- *ON/OFF* ›› activate/deactivate
- 
-  End

### Activate/deactivate discreet ring mode

- *Beeps*
- *3 Beeps + Ringing*
- *ON/OFF* ›› activate/deactivate
- 
-  End

### Adjust ringer volume while a call arrives



- Your telephone rings
-   Adjusting the ringer volume

## 8.5 Adjusting the contrast of the display (8028/8029/8038/8039 Premium DeskPhone)

- Reach the “Menu“ page
- *Settings* › *Phone* › *Contrast*
- *Screen* or *Keys* ›› Increase or reduce the brightness of the screen or keys (of the extension unit) by pressing consecutively on the corresponding keys

## 8.6 Selecting the welcome page

This function is used to choose the page displayed by default on the telephone.



- *Settings* › *Options* › *Homepage*
- Select the default page
- 
- 

## 8.7 Selecting language



- Reach the “Menu“ page
- *Settings* › *Options* › *Language*
- Select the language of your choice
- 

## 8.8 Programming direct call keys (Perso page)



You can program keys of the perso page.

- Access the Perso page using the navigator
- If the key is not programmed yet:
  - Select the key to program
  - Enter the name and number to associate to the key
  - 
- If the key is already programmed:
  - 
  - Select the key to program
  - Enter the name and number to associate to the key
  - 

## 8.9 Deleting direct call keys (Perso page)

- Access the Perso page using the navigator
- 
- Select the key to delete
- *Clear*
- 

## 8.10 Programming direct call keys (F1 and F2 keys)

- Press a programmable key (F1 or F2)
- If the key is not programmed yet:
  - Select the key to program
    - Enter the name and number to associate to the key
    - 
- If the key is already programmed:
  - 
  - Select the key to program
  - Enter the name and number to associate to the key
- 



## 8.11 Deleting direct call keys (F1 and F2 keys)

- 
- Select the key to delete
- *Clear*
- 



## 8.12 Programming direct call keys (8028/8029 Premium DeskPhone)

The phones have four programmable keys with Leds and paper labels.

Led behavior may differ depending on the system configuration. For more information, contact your installer or administrator.

- If the key is not programmed yet:
  - Select the key to program
  - Enter the name and number to associate to the key
-  Validate the name and number.
- If the key is already programmed:
  - 
  - Select the key to program
  - Enter the name and number to associate to the key
  -  Validate the name and number.

## 8.13 Deleting direct call keys (8028/8029 Premium DeskPhone)

- 
- Select the key to delete
- *Clear*
- 

## 8.14 Programming an appointment reminder

You can set the time of a temporary reminder (one within 24 hours) or a permanent reminder (every day at the same time)

- Reach the “Menu“ page
- *Appointment*
- Enter time of appointment
- *Temporary / Permanent* >> Select the type of appointment (temporary or permanent)
- 

The “Appointment programmed“ icon is displayed on the welcome page.

At the programmed time, your telephone rings:

- 

If your calls are forwarded to another terminal, the forward is not applied to the reminder call.

To cancel your reminder request:

- Reach the “Menu“ page
- *Appointment*
- *Temporary / Permanent* >> Select the type of appointment (temporary or permanent)
- *Clear*
- 

The “Appointment programmed“ icon disappears from the welcome page.

## 8.15 Identify the terminal you are on

The number of your telephone is displayed on the “Info“ page.

## 8.16 Lock / unlock your telephone

 This icon indicates that the phone is locked.

- Reach the “Menu“ page
- *Lock*
- Enter your password >> Your telephone is locked/unlocked

## 8.17 Configuring the audio jack of your telephone

By default, the audio jack of your telephone can be used to connect a headset, hands-free kit or loudspeaker. A wideband headset can also be installed for optimized sound quality.

- Reach the “Menu“ page
- *Settings > Phone > Jack*
- *Headset / Handsfree / Loudspeaker >>* Select the type of device plugged into the jack
- 

## 8.18 Activating/Deactivating “Forced headset“ mode

- Reach the “Menu“ page
- *Settings > Phone > ForcedHead*
- *ON/OFF >>*activating/deactivating forced headset

## 8.19 Installing a Bluetooth® Wireless Technology handset (matching)

This feature is only available with compatible Bluetooth® phone (8068 Bluetooth® Premium DeskPhone). Otherwise the corresponding menu is not displayed or is inactive.

Before a Bluetooth® headset can be used, it must be correctly matched to the terminal.

- Reach the “Menu“ page
- *Settings > Phone > Bluetooth > Adddevices*
-  With the handset turned off, press the 2 Bluetooth® handset keys at the same time (long press)

>> You will hear a 3 note signal and the LED will flash green and orange alternately

>> Searching for Bluetooth® equipment. Wait for the detected equipment type and address to be displayed

- Select the relevant equipment
- *Add >>* The 3-note tone indicates that the handset has been installed correctly (the LED flashes green or orange depending on the battery charge level)

### Error messages

The Bluetooth® handset emits a sequence of 4 beeps	>>	Your set is an older generation than your Bluetooth® handset
The set displays an error message indicating that the set and the Bluetooth® handset are incompatible	>>	Your Bluetooth® handset is an older generation than your set



## 8.20 Use of the Bluetooth® handset

The Bluetooth® Wireless handset is only available with the 8068 Bluetooth® Premium DeskPhone .  
The Bluetooth® cordless handset permits the user to answer and converse with complete freedom within a radius of 10 meter from the set.  
The handset has a LED and two buttons.

### Light

- Green flashing: normal operation.
- Green steady: handset charging.
- Orange flashing: battery charge low or handset outside coverage zone.
- Orange steady: malfunction.

### Off-hook/On-hook and Volume/Mute keys

-  Off-hook/On-hook: press this key to take or terminate a call.
-  Volume/Mute:
  - Short successive presses to change the handset volume level (3 levels)
  - Long press to ensure your caller no longer hears you

If the Bluetooth® handset is on its base, you do not need to press the Off-hook/On-hook key to take or terminate the call. Just off-hook/on-hook the Bluetooth® handset

## 8.21 Installing a Bluetooth® Wireless Technology headset (matching)

This feature is only available with compatible Bluetooth® phone (8068 Bluetooth® Premium DeskPhone). Otherwise the corresponding menu is not displayed or is inactive.

A multi-point Bluetooth headset can be provided by ALE International.



This headset can be matched to your mobile phone and other communication devices at the same time. For example, you can use the headset matched to your mobile and when you enter your office the headset automatically matches to your office set too.

You can then answer a call using your Bluetooth headset or the Bluetooth Handset on the office set.

Before a Bluetooth® headset can be used, it must be correctly matched to the terminal. Before performing the matching operation, the headset must be in detectable mode.

- Reach the “Menu“ page
- *Settings* > *Phone* > *Bluetooth* > *Adddevices*

» Searching for Bluetooth® equipment. Wait for the detected equipment type and address to be displayed

- Select the relevant equipment
- *Add*
-  Validate your choice
- Enter the PIN code of the headset \*
-  » Acknowledgement message and display of the headset icon on the terminal screen

\*Refer to the user documentation supplied with the headset.

## 8.22 Using a Bluetooth® Wireless Technology headset

Refer to the user documentation supplied with the headset.

## 8.23 Deleting an accessory (headset, handset, etc.): Bluetooth® Wireless Technology

This feature is only available with compatible Bluetooth® phone (8068 Bluetooth® Premium DeskPhone). Otherwise the corresponding menu is not displayed or is inactive.

- Reach the “Menu“ page
- *Settings* › *Phone* › *Bluetooth* › *Mydevices*

›› Display of the different equipment matched

- Select the equipment to be removed
- *Remove dvc*
-  Validate your choice

›› Message acknowledging the equipment has been removed

## 8.24 Contacting your administrator

If necessary you may need to contact your administrator.

Before contacting your administrator make sure you have information such as your phone's part number and software version to hand.

### The part number

The phone's part number is located under the foot of the phone.

### Software version

The software version can be viewed on the phone by following this path:

- *System* › *SWVersion*
- A multi-point Bluetooth headset can be provided by ALE International.



# 9 ACD: Agent set / Supervisor station

## 9.1 Agent set

A call center solution allows optimum distribution of calls to agents according to their availability and skills.

## 9.2 Open an agent session (login) - Agent set

- Select the ACD application
- *Login*
- Select the agent and validate
- 
- Depending the displayed information, enter your password or confirm

» ACD application welcome screen is displayed.

## 9.3 ACD application welcome screen - Agent set

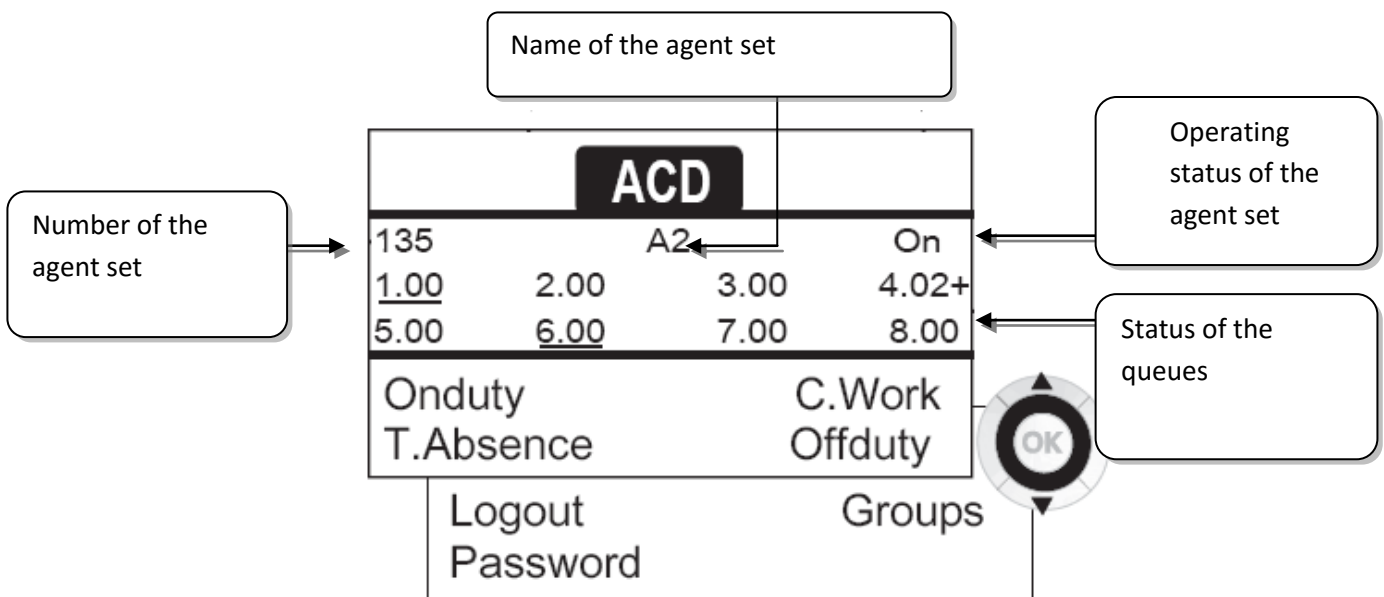

4.02 means: group number 4 2 calls waiting the + sign indicates that the queue capacity has been reached .

## 9.4 The four operating statuses of the agent set

An agent's availability is determined by the operating status (of which there are 4), that the agent can change at any time. These statuses are:

- *Onduty* » In service, the agent is ready to receive calls.
- *Offduty* » Withdrawn , the agent has withdrawn from the ACD application
- *C.Work* » Additional task, the agent is performing a task concerning a call and is not taking other calls
- *T.Absence* » Temporarily absent, the agent has taken a break and is not taking calls.

The agent can change the operating status directly by entering codes (on all sets), by pressing the function keys on the set (8028 Premium DeskPhone, 8029 Premium DeskPhone, 8038 Premium DeskPhone, 8039 Premium DeskPhone and 8068 Premium DeskPhone), or using the Agent Assistant agent software on PC (if available).

## 9.5 Changing the operating status of the set - Agent set

### Changing using codes (all sets)

The operating status change codes are defined when the system is configured. Contact the system administrator to obtain these codes.

- Enter the feature code to activate

### Change by function keys (8028 Premium DeskPhone, 8029 Premium DeskPhone, 8038 Premium DeskPhone, 8039 Premium DeskPhone and 8068 Premium DeskPhone)

- Press the function key of the status to be activated. Information relative to the selected status is displayed on the screen. If a refusal message is displayed, contact the system administrator.

## 9.6 Modifying your personal code - Agent set

- *Password*
- New code (6 digits)

## 9.7 Integrating another group/leaving a group - Agent set

- *Groups*
- Press the key of the group (1 to 8) to integrate (box empty) and/or press the key of the group to leave (box full)

## 9.8 Close the agent session (logout) - Agent set

- *Logout*

## 9.9 Supervisor station

- A supervisor can consult the messages left in the voice mailboxes of the call centre groups (maximum 8 groups) using the function keys on a 8028 Premium DeskPhone, 8029 Premium DeskPhone, 8038 Premium DeskPhone, 8039 Premium DeskPhone or 8068 Premium DeskPhone.

A supervisor can also perform the agent function from the same set

## 9.10 Supervising group mailboxes - Supervisor station

### Consulting the messages:

When a message is left in a group mailbox, the voice mail present indicator associated with the supervision key flashes.

- Press the supervision key
- Follow the instructions of the voice guide

When a mailbox is consulted by a supervisor, the other supervisors cannot access it

### Supervision keys for group mailboxes and positioning on the sets:

- Access the Perso page to display the positioning of the supervision keys on the sets.

# 10 Guarantee and clauses

---

## 10.1 Safety Instructions

- Changes or modifications to the equipment not expressly approved by the party responsible for compliance could void the user's authority to operate the equipment.
- Magnets could affect the functioning of pacemakers and implanted heart defibrillators. Keep a safe distance between your pacemaker or implant defibrillator and the handset which includes magnetic elements: 4 centimeters (1,6 inches) at least
- To limit the risk of interference, people with pacemakers must keep the wireless telephone away from their equipment (minimum distance of 15 cm/6 inches)
- It is recommended to follow the standard acceptance procedures before using this equipment in human safety critical areas (hospitals...).
- The handset includes magnetic elements that may attract sharp metallic objects. To prevent injury, before each use ensure sharp metallic objects are not stuck to the earpiece and microphone.
- There is a danger of explosion if the battery is replaced incorrectly - use only the battery with the reference 3GV28041AB (1.2V 1500 mAh) (Bluetooth® Handset only).
- Battery charge (Bluetooth® Handset only): Charge the battery for about 16 hours before initial use
- Avoid using phones (other than cordless type) during an electrical storm. There may be a remote risk of electric shock from lightning
- Do not use the device in environments where there is a danger of explosion
- Do not plug this phone into an Integrated Services Digital Network (ISDN) connection or into a regular Public Switched Telephone Network (PSTN) connection. This can result in severe damage to the phone
- Never allow your telephone to come into contact with water
- To clean your telephone, use a soft damp cloth. Never use solvents (trichlorethylene, acetone, etc.) which may damage the plastic parts of your telephone. Do not use aerosol cleaners.
- This product is intended to be connected to the PABX via the LAN (10/100/1000 MB)
- If you are connected to a POE connection do not use an external Power Supply.
- The PoE (Power over Ethernet) devices that supply or receive power and their connected cables must all be completely indoors.
- The RJ-45 jack is not used for telephone line connection
- The 8068 Premium DeskPhone also offers a Bluetooth® Radio Interface for the Bluetooth® handset or other Bluetooth® devices - frequency range 2402-2480 MHz, Radiated Power 1mW.

## 10.2 Regulatory Statements

### Marking



This equipment is in compliance with the essential requirements of Radio Equipment Directive (RED) 2014/53/EU and with Directive 2011/65/UE (ROHS).

The Declaration of Conformity may be obtained from:

ALE International 32, Avenue Kleber 92700 Colombes

ebg\_global\_supportcenter@al-enterprise.com

### USA and Canada

This device complies with Part 15 of the FCC Rules and with RSS-210 of Industry Canada. Operation is subject to the following two conditions: (1) this device may not cause harmful interference, and (2) this device must accept any interference received, including interference that may cause undesired operation.

### Exposure to Radio Frequency Signals.

This equipment complies with radiation exposure limits set by FCC/IC and the European Council. This equipment has very low levels of RF energy and is deemed to be compliant without testing of the specific absorption rate (SAR).

### User Instructions

Only use the handset in temperatures between -5°C to +45°C (23°F to 113°F). This product is intended for use in an indoor environment only. This apparatus is Hearing Aid Compatible (HAC).

### Acoustic shock protection

Maximum sound pressure level for handset is compliant with European, US and Australian standards.

### Directive 2003/10/EC specifying the risks inherent in noise at work

A wired handset is also available and can replace the Bluetooth® handset.

### Privacy

Privacy of communications may not be ensured when using the Bluetooth® handset or any additional Bluetooth® device.

### Disposal



The equipment must be returned to a collection point for electronic equipment waste disposal. Defective batteries must be returned to a collection point for chemical waste disposal.

### Related Documentation

Other languages for these Safety and Regulatory Instructions and User Documentation are available at the following Web site:

<http://www.al-enterprise.com?product=All&page=Directory>

The labels and icons presented in this document are not contractually binding and may be modified without prior warning

The information presented is subject to change without notice. ALE International assumes no responsibility for inaccuracies contained herein. Copyright 2016 ALE International. All rights reserved.

# Alcatel-Lucent 8068/8038/8028/8039/8029 Premium DeskPhone

- Bluetooth® wireless handset (8068BT).
  - Wired handset.
- One 3.5 mm headset jack
- Function keys
- An adjustable and stable foot
- Alphabetic keypad



- LED**
- Flashing blue: incoming call
  - Flashing orange: alarm

Function keys	
Mute and intercom.	
Handsfree, handset or headset volume. Adjust contrast	
Audio services (handsfree, handset or headset).	
<ul style="list-style-type: none"> <li>Programmable keys (F1 and F2 keys): Lit when the function associated with the key is activated. A service or a direct call can be associated to these keys.</li> <li>Pre-programmed function keys are disabled in "safe " mode. The F1 and F2 keys are line keys.</li> </ul>	
Redial key: to access the 'Redial' feature.	
Guide key: Used to obtain information on functions of the "menu" page and to program key of the "perso" page.	
Messaging key to access various mail services. This key is lit when you have received a new voicemail, text message or callback request.	
Handsfree key To make or answer a call without lifting the receiver.	
END key To terminate a call.	
Bluetooth® wireless handset (8068 Bluetooth® Premium DeskPhone)	
The Bluetooth® Wireless handset is only available with the 8068 Bluetooth® Premium Deskphone.	
	Off-hook/On-hook
	Volume/Mute:
	<ul style="list-style-type: none"> <li>Short successive presses to change the handset volume level (3 levels)</li> <li>Long press to ensure your caller no longer hears you</li> </ul>

### Welcome screens

Contains several lines and pages providing information on calls and the features that can be accessed by pressing the keys associated to the labels on the display (10 keys for 8068/38/39 phones and 6 keys for the 8028/29 phones).

- Menu page: Contains all functions and applications accessible via the keys associated with the words on the screen.
- Perso page: Contains call line keys (allowing supervision of calls) and programmable call keys.
- Info page: Contains information on the telephone and the status of its functions: name, telephone number, number of messages, activation of transfer function, appointment reminder, etc.
- Transfer icon: Pressing the key next to this icon allows you to program or change the transfer function.

### Navigation







- OK key: Used to validate your choices and options while programming or configuring
- Left-right navigator: Used to move from one page to another and display information about current calls (call in progress, calls on hold, incoming call).
- Up-down navigator: Used to scroll through the content of a page
- Use this key to go back to the previous step
- Use this key to go back to the homepage (long press)

### Status icons / Call icons

	Headset connected		Incoming call icon
	Telephone locked		Call in progress icon
	Appointment programmed		Call holding icon

Alphabetic keypad	Add-on module
Cursor moving keys (left, right, up and down).	The 8028/8029 Premium Deskphone has 4 programmable keys with LED and paper labels. Phone capabilities can be extended with Premium Add-on 10- and 40-key modules or Premium Smart display 14-key module.
Caps lock: to write text in capital letters.	
Alt key: to access the purple characters and features.	
Enter key: to validate edited text.	
Backspace key: to delete one character in an edit box.	

All features are described for OmniPCX Office and OmniPCX Enterprise Systems. If a feature works differently on each system it is described twice. The label displayed on the phone depends on the type of phone. This guide provides the labels for 8068/38/39 phones plus 8028/29 phone labels in parentheses (if different).

<b>Call</b> <ul style="list-style-type: none"> <li>Dial the number directly or dial the number after pressing a line key (an off-hook key phone or Bluetooth handset, hands-free key)</li> </ul>		<b>Do not disturb</b> <ul style="list-style-type: none"> <li>Press the key associated to the forward icon</li> <li><i>DoNotDisturb (DND)</i></li> </ul>	
<b>Call by name (Company directory)</b> <ul style="list-style-type: none"> <li>RCE - Enter the first letters of contact's name and follow the on-screen instructions.</li> <li>OTCT - Enter the name, contact's surname/name or initials and follow the on-screen instructions.</li> </ul>	<b>Switching between calls (Broker call)</b> <ul style="list-style-type: none"> <li>Press the key associated with the call on hold</li> </ul>		
<b>Answer a call</b> <ul style="list-style-type: none"> <li>Take the handset off the hook, use an off-hook key (phone or Bluetooth handset), use hands-free key, or press the key next to the incoming call icon</li> </ul>	<b>To cancel your second call and recover the first:</b> <ul style="list-style-type: none"> <li>You automatically recover the first call</li> </ul>	<b>Send text messages</b> <ul style="list-style-type: none"> <li><i>Message</i></li> <li><i>SendTxtMsg</i></li> <li>Enter the destination number</li> <li>Select the type of message to send (fixed Msg, New Msg,...)</li> </ul>	
<b>Ignore call / End the call</b>	<b>Transferring a call</b> <ul style="list-style-type: none"> <li>You are in conversation with one caller</li> <li>Call a second contact</li> <li>Transfer the call</li> </ul>	<b>Read text messages</b> <ul style="list-style-type: none"> <li><i>Message</i></li> <li><i>ReadTxtMsg</i></li> </ul>	
<b>Redial</b> <ul style="list-style-type: none"> <li>Long press to access the list of the last 10 dialed numbers</li> <li>Short press to call the last dialed number</li> </ul>	<b>Conference</b> <ul style="list-style-type: none"> <li>Call the first contact</li> <li>Call the second contact</li> <li><i>Conference (Conf)</i></li> </ul>	<b>Instant Messaging (RCE)</b>	
<b>Make a call-back request to a busy number</b> <ul style="list-style-type: none"> <li><i>Callback</i></li> </ul>	<b>Make calls via your programmed call keys</b> <ul style="list-style-type: none"> <li>Press the desired programmed call key</li> </ul>	<b>Consulting the Call log (RCE)</b>	
<b>Placing a call on hold (hold)</b> <ul style="list-style-type: none"> <li><i>Hold</i></li> </ul>	<b>Modify the programmed key</b> <ul style="list-style-type: none"> <li>Press the programmed key to be modified</li> <li>Follow the on-screen instructions</li> </ul>	<b>Information about the phone</b>	Info
<b>Sending DTMF signals</b> <ul style="list-style-type: none"> <li><i>UMFcode</i> (RCE), <i>Send DTMF</i> (OTCT)</li> <li>Send numbers</li> </ul>	<b>Erase a programmed key</b> <ul style="list-style-type: none"> <li><i>Settings</i> &gt; <i>Keys</i> (RCE)</li> <li><i>Settings</i> &gt; <i>Phone</i> &gt; <i>Key program</i> (OTCT)</li> <li>Select the key to be erased</li> <li>Follow the on-screen instructions</li> </ul>	<b>Lock/unlock the phone</b> <ul style="list-style-type: none"> <li><i>Lock</i></li> </ul>	Menu
<b>Mute</b>	<b>Customizing your voice greeting</b> <ul style="list-style-type: none"> <li><i>Settings</i></li> <li><i>Mailbox</i></li> <li>You can listen to the greeting, customize the greeting and set the default greeting</li> </ul>	<b>Adjust audio volume</b>	
<b>Interphony</b> <ul style="list-style-type: none"> <li>The phone automatically answers the call.</li> <li>Before the line is taken, you hear a succession of specific beeps.</li> </ul>	<b>Consulting your voice mailbox</b>	<b>Select the language of your choice</b> <ul style="list-style-type: none"> <li><i>Settings</i> &gt; <i>Options</i> &gt; <i>Language</i> (RCE)</li> <li><i>Settings</i> &gt; <i>Phone</i> &gt; <i>Language</i> (OTCT)</li> </ul>	Menu
<b>Making a second call during a conversation</b> <ul style="list-style-type: none"> <li><i>New call</i></li> </ul>	<b>Diverting calls to your voice mailbox</b> <ul style="list-style-type: none"> <li>Press the key associated to the forward icon</li> <li><i>Immediate&gt;VM</i></li> <li>Press the key associated with the type of call forward required</li> </ul>	<b>Choose the tune</b> <ul style="list-style-type: none"> <li><i>Settings</i> &gt; <i>Phone</i> &gt; <i>Ringin</i></li> <li>Adjust the ring via the following menus: Melody, Silent, Beeps, Volume, etc.</li> </ul>	Menu
<b>Answering a second call during a conversation</b> <ul style="list-style-type: none"> <li>Press the key associated with the incoming call</li> </ul>	<b>Cancel forward</b> <ul style="list-style-type: none"> <li>Press the key associated to the forward icon</li> <li><i>Cancel fwd.</i></li> </ul>	<b>Adjusting screen contrast</b> <ul style="list-style-type: none"> <li><i>Settings</i> &gt; <i>Phone:</i> &gt; <i>Contrast</i></li> </ul>	Menu
		<b>Modify the password for your phone set</b> <ul style="list-style-type: none"> <li><i>Settings</i> &gt; <i>Options</i> &gt; <i>Password</i> (RCE)</li> <li><i>Settings</i> &gt; <i>Phone</i> &gt; <i>Password</i> (OTCT)</li> </ul>	Menu
		<b>Homepage</b> <ul style="list-style-type: none"> <li><i>Settings</i> &gt; <i>Options</i> &gt; <i>Homepage</i> (RCE)</li> <li><i>Settings</i> &gt; <i>Phone</i> &gt; <i>Homepage</i> (OTCT)</li> <li>Select the default page</li> </ul>	Menu