

Dialog 4106 Basic/Dialog 4147 Medium

Analog Telephones

User Guide



EN/LZT 103 78 R1A
© Ericsson Enterprise AB 2004

Table of Contents

	page
General Information	5
Description	7
Incoming Calls	12
Outgoing Calls	13
During Calls	18
Settings	20
Installation	27
Troubleshooting	32
Index	33

General Information

The latest version of this user guide can be downloaded from:
<http://www.ericsson.com/enterprise/>

Copyright

All rights reserved. No parts of this publication may be reproduced, stored in retrieval systems, or transmitted in any form or by any means, electronic, mechanical, photocopying, recording or otherwise, without prior written permission of the publisher except in accordance with the following terms.

If this publication is made available on Ericsson media, Ericsson gives its consent to downloading and printing copies of the content provided in this file only for private use and not for redistribution. No parts of this publication may be subject to alteration, modification or commercial use. Ericsson will not be liable for any damages arising from use of an illegal modified or altered publication.

Warranty

ERICSSON MAKES NO WARRANTY OF ANY KIND WITH REGARD TO THIS MATERIAL, INCLUDING, BUT NOT LIMITED TO, THE IMPLIED WARRANTIES OF MERCHANTABILITY AND FITNESS FOR A PARTICULAR PURPOSE. Ericsson shall not be liable for errors contained herein nor for incidental or consequential damages in connection with the furnishing, performance or use of this material.

Declaration of Conformity

Hereby, Ericsson Enterprise AB, SE-131 89 Stockholm, declares that this telephone is in conformity with the essential requirements and other relevant provisions of the R&TTE directive 1999/5/EC.

Details to be found at:

<http://www.ericsson.com/sdoc>

Description

Dialog 4106 Basic

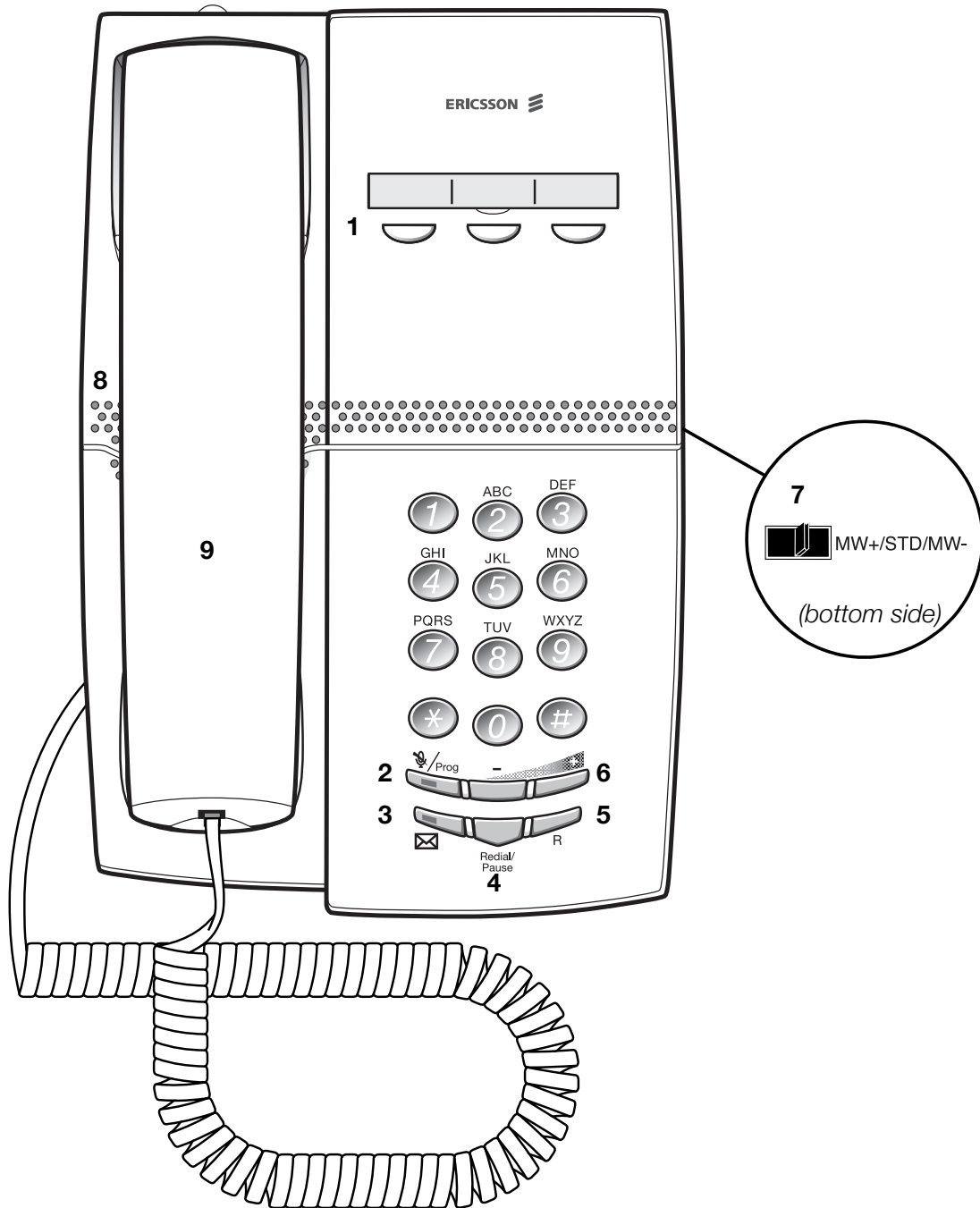

1 Programmable keys

Three keys for storing frequently called numbers. You can store one number per key, see section “[Dial By a Function Key](#)” on page 15.

Note: *If you unplug the telephone, stored numbers will remain for about 24 hours.*

2 Mute/Prog

- a. Switch microphone on or off. See section “[During Calls](#)” on page 18.
- b. Enter programming mode. See section “[Settings](#)” on page 20.

3 Message Waiting key

- a. A flashing light indicates a waiting message.
- b. Programmable key for storing of one frequently called number. See section “[Dial By a Function Key](#)” on page 15

4 Last number redial/Pause key

- a. Redial last number dialed. See section “[Last Number Redial](#)” on page 14.
- b. Insert a pause if you have to wait for dial tone when programming a number into the memory. See section “[Wait for dial tone](#)” on page 13.

5 R-key

Used for example to make an inquiry, to transfer a call or to establish a conference, see section “[During Calls](#)” on page 18.

6 Volume control

To adjust the volume.

7 Message Waiting switch

Switch Message Waiting indication on or off. Also used to reverse the polarity in case of crossed line cables. See section “[Settings](#)” on page 20.

8 Loudspeaker (beneath handset)

9 Handset with hearing aid function

Please note: *The handset may attract and retain small metal objects in the earcap region.*

Dialog 4147 Medium

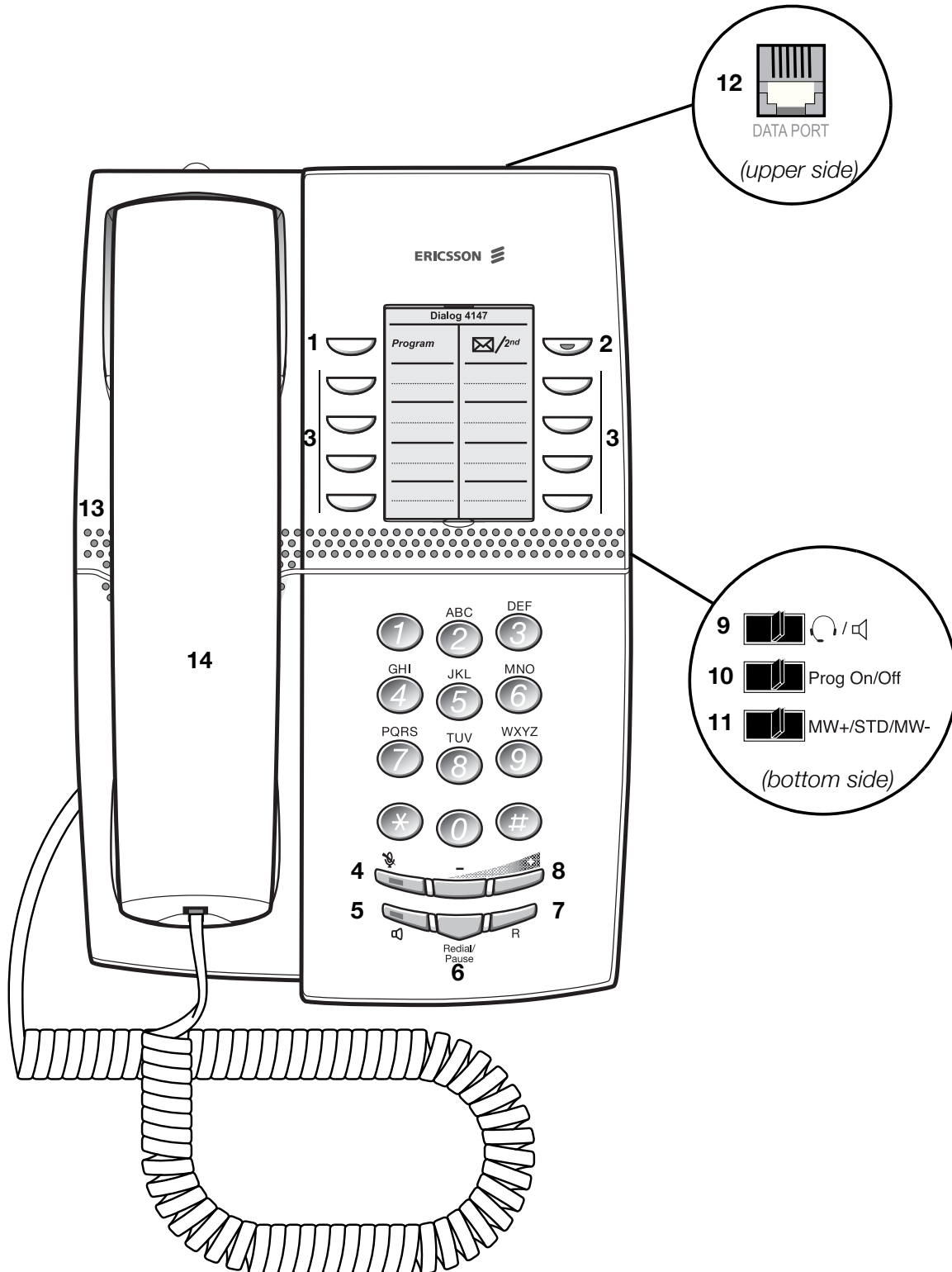

- 1 Program**
Store frequently called numbers.
- 2 Message Waiting/2nd**
 - a. A flashing light indicates a waiting message.
 - b. Key for access to secondary key functions (these functions are stated on the second line of the corresponding key).
- 3 Programmable keys**
Eight keys for storing frequently called numbers. You can store two numbers per key.
- 4 Mute**
Switch microphone on or off. See section “[During Calls](#)” on [page 18](#).
- 5 Loudspeaker on/off / Headset key**
 - a. Switch loudspeaker on or off. See section “[During Calls](#)” on [page 18](#).
 - b. Activate headset. See section “[Headset](#)” on [page 25](#).
- 6 Last number redial/Pause key**
 - a. Redial last number dialed. See section “[Last Number Redial](#)” on [page 14](#).
 - b. Insert a pause if you have to wait for dial tone. See section “[Wait for dial tone](#)” on [page 13](#).
- 7 R-key**
Used for example to make an inquiry, to transfer a call or to establish a conference, see section “[During Calls](#)” on [page 18](#).

Note: Sometimes it is required to change the flash time for the R-key, see section “[Flash time](#)” on [page 26](#).
- 8 Volume control**
To adjust the volume.
- 9 Headset/Loudspeaker switch**
 - a. At the headset position, the loudspeaker key activates a connected headset. See section “[Settings](#)” on [page 20](#).
 - b. At the loudspeaker position, the loudspeaker key activates the loudspeaker. See section “[Settings](#)” on [page 20](#).
- 10 Prog On/Off switch**
Enable or disable the program key. See section “[Settings](#)” on [page 20](#).

- 11 Message Waiting switch**
Switch Message Waiting indication on or off. Also used to reverse the polarity in case of crossed line cables. See section "[Settings](#)" on page 20.
- 12 Data port**
Data port for connection of a modem, PC or other telephone equipment.
- 13 Loudspeaker (beneath handset)**
- 14 Handset with hearing aid function**

Please note: *The handset may attract and retain small metal objects in the earcap region.*

Incoming Calls

A ring signal indicates an incoming call.

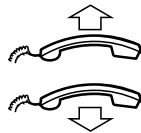

Answer calls

Lift the handset.

Replace the handset to end the call.

Outgoing Calls

Make calls

How to make calls.

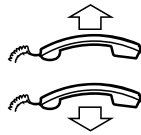

Lift the handset and dial the number.

Replace the handset to end the call.

Wait for dial tone

Sometimes it is required to wait for a new dial tone after dialing the prefix digit when making an external call. In such situations, you must store the pause for a new dial tone into the number:

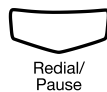

Press.

Manual dial pause control:

You can control the length of a dial pause manually if you store the pause after the fifth digit or later. This function is very useful, if you are connected to a PBX that requires a new dial tone for extension numbers.

Example:

You want to talk to Steven. Steven's company has the number 12345678, and his extension is 1234, so the complete number is 12345678-1234. To wait for a new dial tone, you have to store a pause before the extension number.

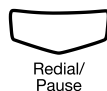

Press.

The phone number is dialed without the extension, in this example 12345678.

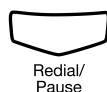

Press when the new dial tone is received.

Now the extension number is dialed.

Number presentation restriction

If you do not want your name and number to be displayed to the person you are calling, you can use the following procedure.

Notes:

This function is only available in newer versions of the exchange, and it might be blocked for use on your extension (programmed by your system administrator).

The number presentation restriction is only valid for the ongoing call, i.e. the procedure has to be repeated the next time you want to use it.



***42#**



Lift the handset.

Dial and wait for a new dial tone.

Dial the number.

Your name and number is not indicated on the called person's display.

Last Number Redial

When you initiate a call, the phone automatically stores all the dialed digits, irrespective of whether the call was successful or not. Stored numbers can consist of maximum 32 digits.

Note: *To redial a number that incorporates a wait for a new dial tone, you must indicate to the telephone where in the number it must pause and wait for the new dial tone. To do this, press the Redial/Pause key at the proper place in the number. See section "Wait for dial tone" on page 13.*



Redial/
Pause

Lift the handset.

Press to redial the last dialed number.

Bypass

If this function is allowed from your extension, you can bypass an; *activated Diversion*, *activated Follow-me* or *activated Absence information* on a specific extension.



* 6 0 *



#

Lift the handset.

Dial and enter the extension number.

Press and wait for answer.

Dial By a Function Key

Note: For the Dialog 4147 phone, make sure that the programming slide switch is set to the "Prog On" position. See section "[Enable/Disable Program key](#)" on page 24.

You can program and activate numbers on the programmable keys. On the Dialog 4106 you can also store one number on the Message key. Stored numbers can consist of maximum 21 digits.



Head Office



Lift the handset.

Wait for dial tone.

Press to make a call (pre-programmed).

Notes:

To dial a number that is stored on the second level, press the Message Waiting/2nd key before pressing the pre-programmed key.

Only for Dialog 4147.

Program

How to program a directory number on the programmable keys.

On the Dialog 4106 phone:

The Dialog 4106 has four keys for programming; the three programmable keys and the Message key.

Note: *To store a number on the Message key, just press the key during the following procedure like a normal programmable key.*



Lift the handset.

Wait for dial tone.

Press.

Press a programmable key.

If a number is already stored, it will be erased automatically. If you would like to erase a number, store a 0 instead of the telephone number.

Dial the number.

You can also store a pause (multiple pauses possible), the R-key function or any code that contains * or #. To store a number that incorporates a wait for a new dial tone, see section “[Wait for dial tone](#)” on page 13.

Press.

Replace the handset.

Notes:

You can write the names above the keys on the self-adhesive label. Because of the special label material, you can also erase and re-write any key name.

If you press an invalid key during programming, the programming mode will be terminated automatically and you will hear a special rejection tone.

On the Dialog 4147 phone:



Lift the handset.

Wait for dial tone.



Press.



Press a programmable key.

Note: To store a number on the second level, press the Message Waiting/2nd key before pressing the programmable key.

If a number is already stored, it will be erased automatically. If you would like to erase a number, store a 0 instead of the telephone number.



Dial the number.

You can also store a pause (multiple pauses possible), the R-key function or any code that contains * or #. To store a number that incorporates a wait for a new dial tone, see section “[Wait for dial tone](#)” on page 13.



Press.



Replace the handset.

Notes:

You can remove the transparent cover in order to write the names beside the keys.

If you press an invalid key during programming, the programming mode will be terminated automatically and you will hear a special rejection tone.

During Calls

Group listening (loudspeaking)

Note: *This function is only for the Dialog 4147 phone.*

This function lets other people in your room listen to your phone conversation. You speak in the handset while the other party's voice is heard on the loudspeaker.



During an ongoing conversation:

Press to switch between loudspeaker and handset.

When the key lamp is lit, the other party's voice is heard on the loudspeaker.

Note: *You can adjust the volume, see section "[Settings](#)" on page 20.*

Monitoring

Note: *This function is only for the Dialog 4147 phone.*

You have an ongoing conversation via the handset.



Press to switch the loudspeaker on.



Replace the handset.

The loudspeaker monitors the call.

Note: *When the loudspeaker is on, the microphone is automatically switched off in the handset. You can adjust the volume, see section “Settings” on page 20.*



Press to end the call.

From Monitoring to handset



Lift the handset.

Continue your conversation via the handset.

Mute

You have an ongoing conversation.



Press to switch the microphone on or off.

When the lamp lights, the caller will not be able to hear the conversation in your room.

Note: *Mute key looks slightly different on the Dialog 4147 phone.*

Settings

The Dialog 4106 and Dialog 4147 phones are equipped with a couple of setting options, you can for instance set and adjust a personal volume and ring signal.

Handset, headset and loudspeaker volume

There are two separate volume settings, one for the loudspeaker and one for the handset/headset. Use the Volume keys to change the volume of the handset/headset or loudspeaker during a call.

- Adjust the handset listening volume when the handset is off hook.
- Adjust the headset listening volume when the headset is activated.
- Adjust the loudspeaker volume when dial tone is heard via the loudspeaker.



Press to change the volume.

Programming of ring signal

By programming, you can adjust the ring character and ring volume. To change the ring character and volume, you have to enter the programming mode.

Programming the ring character and volume for the Dialog 4106

The ring signal character can be adjusted with three different characters, each with another three volume levels.



Lift the handset.

Wait for the dial tone.

Press.

#

Press.



Enter digit from the table below.

Digit (character)	Ring character – Repetition rate	Ring volume
1	1 time	Soft
2	1 time	Medium
3	1 time	Loud
4	4 times	Soft
5	4 times	Medium
6 (default)	4 times	Loud
7	10 times	Soft
8	10 times	Medium
9	10 times	Loud
0	None	Off

Notes:

Default setting is digit 6. If you choose 0, the ring signal will be turned off until the next time you go off hook.

Please note also that you will not hear the ring signal during programming.



Press.

The selected ring signal is stored.



Replace the handset to finish the procedure.

Programming the ring character and volume for the Dialog 4147

The ring signal character can be adjusted with five different characters and three different volume levels.

Program ring character:



Lift the handset.

Wait for the dial tone.



Program

Press.

7

Press.



Enter digit from the table below.

You can hear the chosen character.

<i>Digit (character)</i>	<i>Ring character – Repetition rate</i>
0	1 time
1	2 times
2	4 times
3	6 times
4	10 times

Note: *Default setting is digit 0.*



Program

Press.

The selected ring character is stored.



Replace the handset to finish the procedure.



Program ring volume:

Lift the handset.

Wait for the dial tone.



Program

Press.

6

Press.



Enter digit from the table below.

You can hear the chosen volume.

<i>Digit (character)</i>	<i>Ring volume</i>
1	Soft
2	Medium
3	Loud

Note: *Default setting is digit 3.*



Program

Press.

The selected ring volume is stored.



Replace the handset to finish the procedure.



Switch off/on ring signal:

Lift the handset.

Wait for the dial tone.



Program

Press.

9

Press.

0 or 1

Press.

0=Off and 1=On. Default setting is digit 1.



Program

Press.



Replace the handset to finish the procedure.

Hearing aid compatibility

Since your telephone has a built-in inductive coupler for the hard-of-hearing, anyone so desiring can use the telecoil in his/her hearing aid while telephoning. To do so, simply switch the hearing aid in the T position.

Message Waiting indication

Your incoming messages can be indicated by a rapidly flashing Message key. It is well known that the line leads could be twisted after installation (the Message Waiting LED will be on when there is no Message Waiting signal and will go off when there is a Message Waiting signal). To solve this problem there are three possible settings for the Message Waiting indication:

- **STD**. This setting should be used when no Message Waiting indication is required. This is also the default setting upon delivery.
- **MW+**. Use this position when Message Waiting indication is required and the line cabling is straight.
- **MW-**. Use this position when Message Waiting indication is required and the line cabling is twisted.

At the bottom side of your phone:

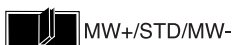

Slide the switch to the required position.

Enable/Disable Program key

Note: *This function is only supported for the Dialog 4147 phone.*

Via a switch it is possible to enable or disable the program key. When the switch is set in the **Off** position, no programming is possible (i.e. the memory content is locked).

At the bottom side of your phone:



Slide the switch to the required position.

Headset

Notes:

This function is only supported for the Dialog 4147 phone.

To install the Headset, see section "[Installation](#)" on page 27.

You can adjust the volume of the headset, see section "[Handset, headset and loudspeaker volume](#)" on page 20.

Headset calls are handled via the Loudspeaker/Headset key. To enable the Headset functionality, you have to change the Loudspeaker/Headset switch into the Headset position.

At the bottom side of your phone:



Slide the switch to the required position.



Answer calls

Press to answer.



Press to end the call.



Make calls

With the handset on hook.

Press.



Dial the number.



Press to end the call.

Flash time

Note: *This function is only supported for the Dialog 4147 phone.*

Some systems require a different flash time for the R-key. You can set two different flash times (timed breaks).

Change flash time:



Lift the handset.

Wait for the dial tone.



Program

Press.

2

Press.

0 or 1

Press.

0=100 ms and 1=600 ms. Default setting is digit 0.



Program

Press.



Replace the handset to finish the procedure.

Installation

Install cables

Handset cable to the left

Handset cable to the right

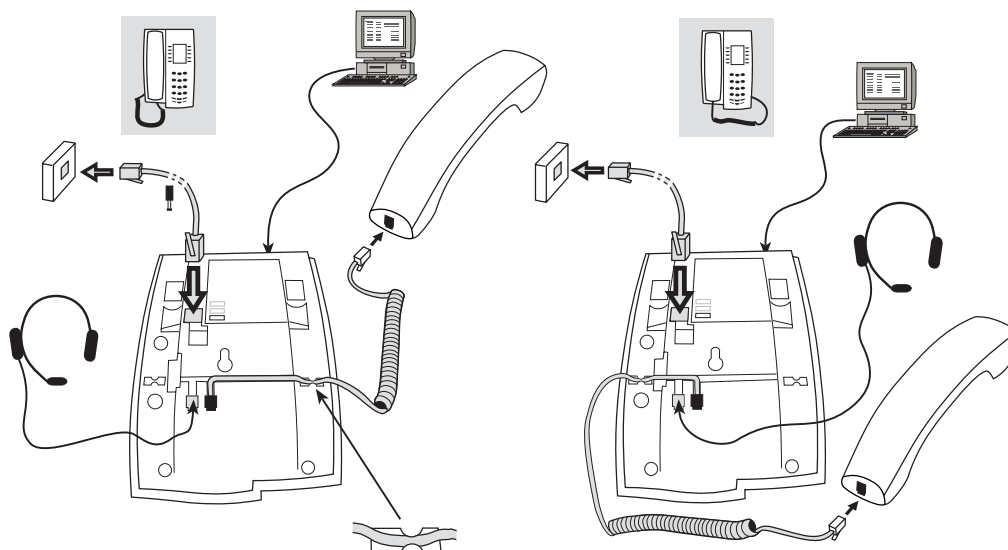

You can put the cable to the handset in the notch underneath the telephone. The cable to the exchange has to be plugged in “LINE” and the handset cable has to be plugged in “HANDSET”.

Note: *The headset and the data port connections are for use with the Dialog 4147 phone only. For headset servicing and replacement, contact your local service centre or retailer shop.*

To change cables:

Use a screwdriver to unlock the stop, and remove the cable.

Install stands and adapt telephone

Position high

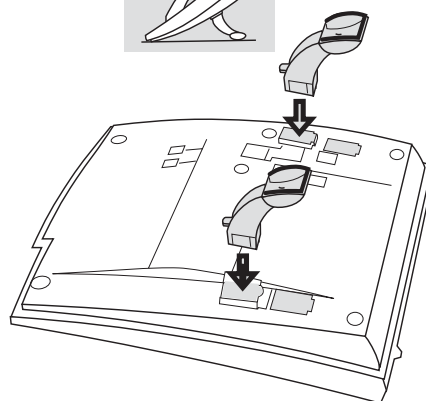
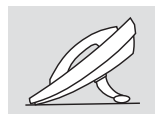

Position low

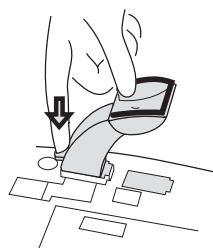
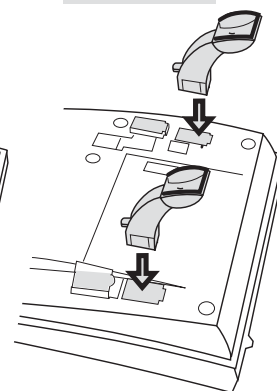

Press to fasten stand

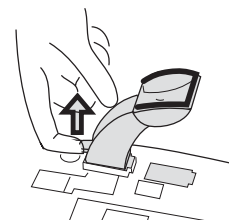

Release to remove stand

Install card

Note: *This section only applies to the Dialog 4147 phone.*

Use the Designation Card Manager to make and print your own designation cards. The Designation Card Manager is included on the Telephone Toolbox CD for MD110 Communication System. For more information, please contact your Ericsson Enterprise certified sales partner.

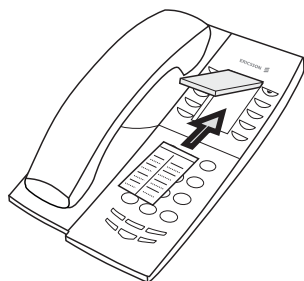

Wall mounting

The phone can be wall mounted without using a special console. Useful for instance in conference rooms or public areas.

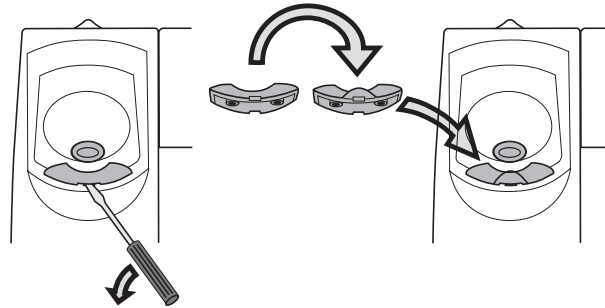

- 1 Use a screwdriver to remove the handset hook.**
- 2 Turn the hook upside down and insert.**

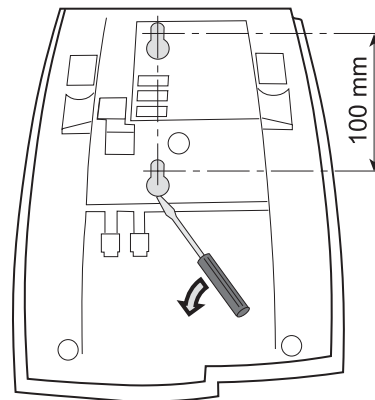

- 3 Use a screwdriver to remove the two plastic covers.**
- 4 Drill wall holes according to measure.**

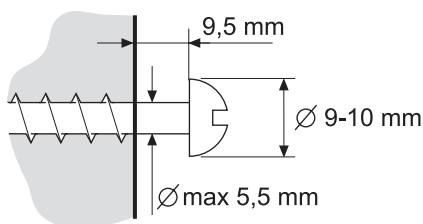

- 5 Mount screws according to measures and attach the phone.**

Placing the telephone

- Do not place your telephone on sensitive surfaces. Use a non-slippery pad to protect your furniture from possible damage.
 - Do not place your telephone near sources of extreme heat, e.g. near the radiator.
 - Make sure that the line cable isn't creased.
-

Cleaning the telephone

Use a slightly moistened (not wet) soft cloth or an anti-static cloth and wipe off the telephone carefully. Do not use rough cloth, solvents or aggressive cleaning fluids. Any damages of the telephone, that are caused by non-observance of these instructions, are not part of the liability given by the manufacturer.

Troubleshooting

This section contains information on how to solve common operational problems. Go through the following steps if you encounter any problems. If this does not solve the problem, contact your system administrator. If others have similar problems, there may be a system error.

Fault check list

- 1. Make sure your telephone is connected to an analog line.**
- 2. Read the Installation chapter.**
Make sure that you have done everything correctly and that everything is properly connected.
- 3. Disconnect all extra equipment.**
If your telephone is working properly when done, the problem lies in the extra equipment.
- 4. Connect a functioning telephone instead of the faulty one.**
If that telephone is working properly, the problem is probably in your telephone, contact your system administrator.
- 5. Check for operational problems.**
If operational problems are found, the problem is in the telephone network, contact the local telephone service or the local telephone company.

Index

A

Answer calls 12

B

Bypass 15

C

Cleaning the telephone 31

Copyright 5

D

Declaration of Conformity 6

Description 7

 Dialog 4106 Basic 7

 Dialog 4147 Medium 9

Dial By a Function Key 15

During Calls 18

 Monitoring 19

 Mute 19

During calls

 Group listening (loudspeaking) 18

F

Fault check list 32

Flash time 26

G

General Information 5

Group listening (loudspeaking) 18

H

Handset, headset and loudspeaker volume 20

Headset 25

Hearing aid compatibility 24

I

Incoming Calls 12

 Answer calls 12

Install cables 27

Install card 29

Install stands and adapt telephone 28

Installation 27

 Cleaning the telephone 31

 Install cables 27

 Install card 29

 Install stands and adapt telephone 28

 Placing the telephone 31

 Wall mounting 30

L

Last Number Redial 14

M

Make calls 13

Message Waiting indication 24

Monitoring 19

Mute 19

N

Number presentation restriction 14

O

Outgoing Calls 13

 Dial By a Function Key 15

 Last Number Redial 14

 Make calls 13

Outgoing calls

 Bypass 15

 Number presentation restriction 14

P

Placing the telephone 31

Programming of ring signal 21

S

- Settings 20
 - Flash time 26
 - Handset, headset and loudspeaker volume 20
 - Headset 25
 - Hearing aid compatibility 24
 - Message Waiting indication 24
 - Programming of ring signal 21

T

- Troubleshooting 32
 - Fault check list 32

W

- Wall mounting 30
- Warranty 5

Ericsson is shaping the future of Mobile and Broadband Internet communications through its continuous technology leadership. Providing innovative solutions in more than 140 countries, Ericsson is helping to create the most powerful communication companies in the world.

Ericsson Enterprise AB
All rights reserved.
For questions regarding the product,
please contact your Ericsson Enterprise Certified Sales Partner.
Also visit us on <http://www.ericsson.com/enterprise>

© Ericsson Enterprise AB 2004
EN/LZT 103 78 R1A

Subject to alteration without prior notice.